

LED strip end feed

LED strip end feed, 5pin COF 12mm (5-pk)

NOR DESIGN

NorDesign AS
www.nordesign.no / tlf: 73 84 95 50

Art. nr. 310923303
GTIN 7070952139359

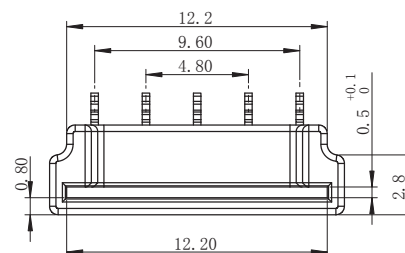
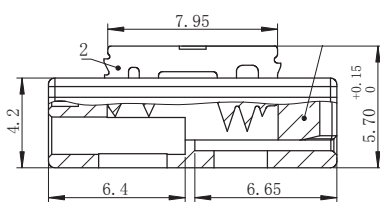
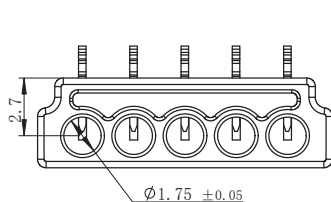
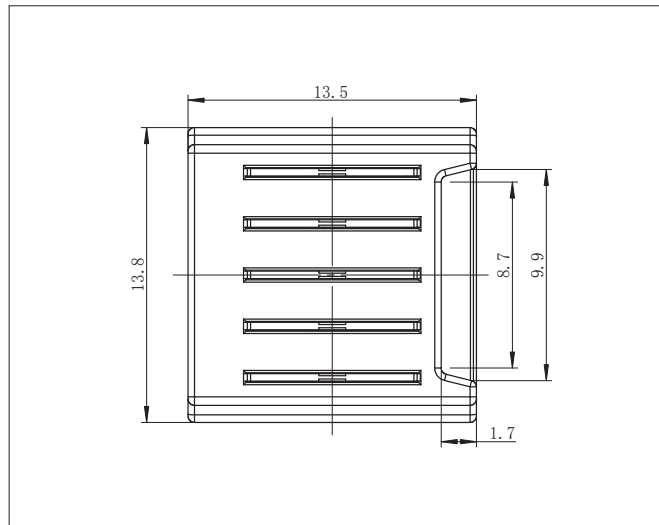
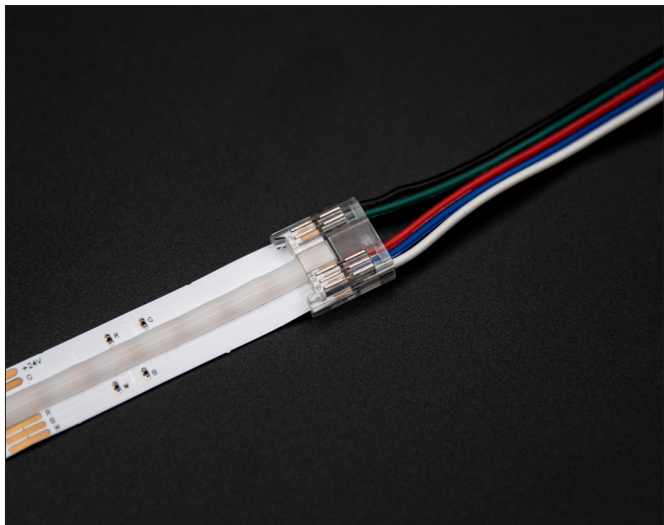

PRODUKT

AWG	22 (0,34mm ²) - Ytre diameter: 1.6±0.1mm
Strøm	6A maks.
Volt	12V / 24V / 48V DC
Driftstemperatur	-20°C - +80°C
Kompatibel med	IP20 COF RGBW
PCB	12mm
Materiale	Polykarbonat (transparent)

IP20 COF RGBW

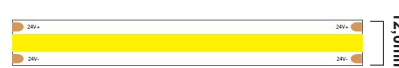

MONTASJE

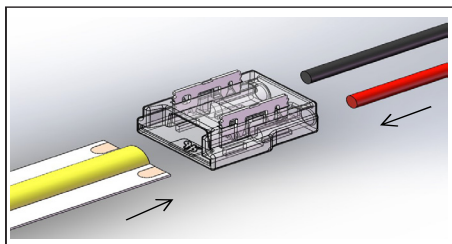

Før kabel og LED-Strip inn i skjøtestykket. Sørg for at farge på kabel stemmer overens med RGBW på LED-Strip.

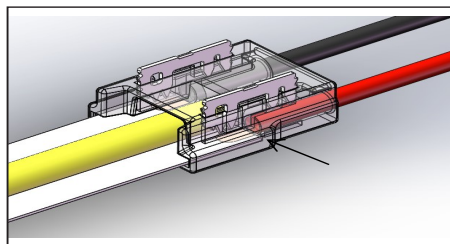

Sørg for at LED-stripen og kabel føres inn helt på midten av skjøtestykket.

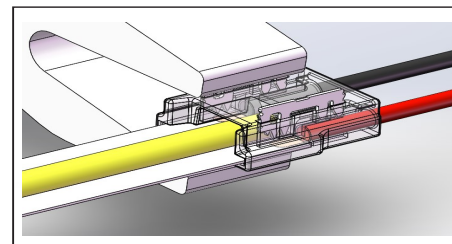

Benytt spesialtilpasset nebbtang til å presse ned metallklemmene. Press jevnt ned og ta en side om gangen.

NB! Ta av tape på undersiden av LED-strip før den føres inn i skjøtestykket.