

# Connector, strip to strip

Connector, strip to strip, 5pin SMD 12mm, 180° (5-pk)

NOR DESIGN

NorDesign AS  
www.nordesign.no / tlf: 73 84 95 50

Art. nr. 310923104  
GTIN 7070952139410

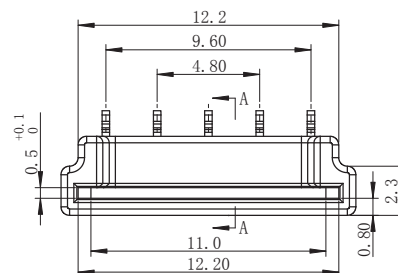
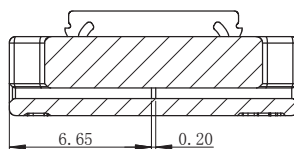
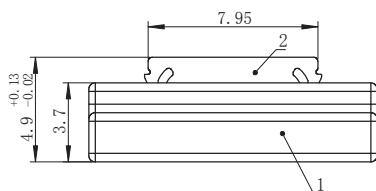
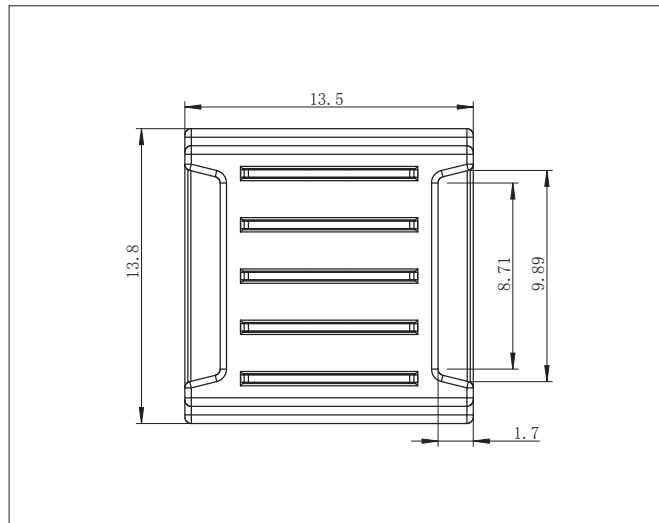

## PRODUKT

Strøm	6A maks.
Volt	12V / 24V / 48V DC
Driftstemperatur	-20°C - +80°C
Kompatibel med	IP20 SMD RGBW
PCB	12mm
Materiale	Polykarbonat (transparent)

### IP20 RGBW



## MONTASJE

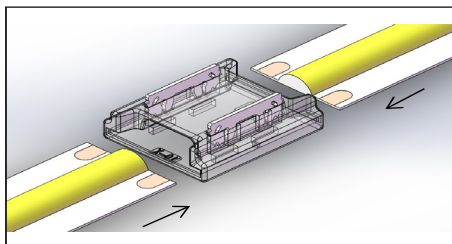

Skv endene på LED-stripene som skal skjøtes sammen inn i skjøtestykket. Sørg for at RGBW på LED-strip er lik på hver side.

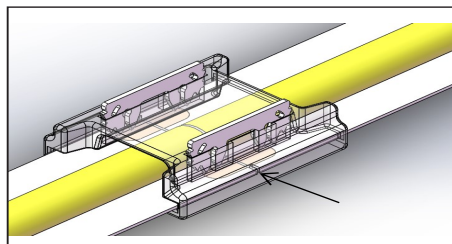

Sørg for at LED-stripene møtes på midten av skjøtestykket.

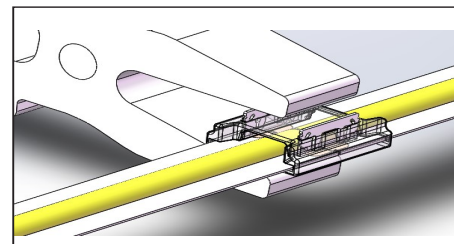

Benytt spesialtilpasset nebbtang til å presse ned metallklemmene. Press jevnt ned og ta en side om gangen.

NB! Ta av tape på undersiden av LED-strip før de føres inn i skjøtestykket.