

Connector, strip to strip

Connector, strip to strip, 5pin SMD 12mm, 180° (5-pk)

NOR DESIGN

NorDesign AS
www.nordesign.no / tlf: 73 84 95 50

Art. nr. 310922104
GTIN 7070952133982

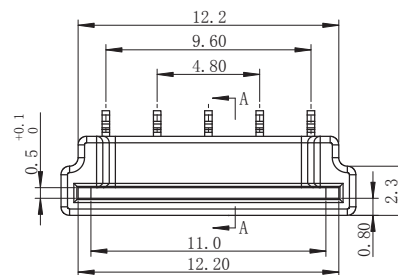
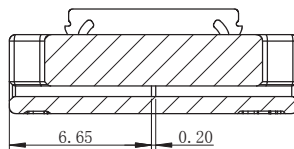
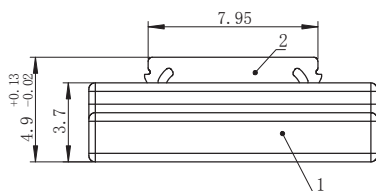
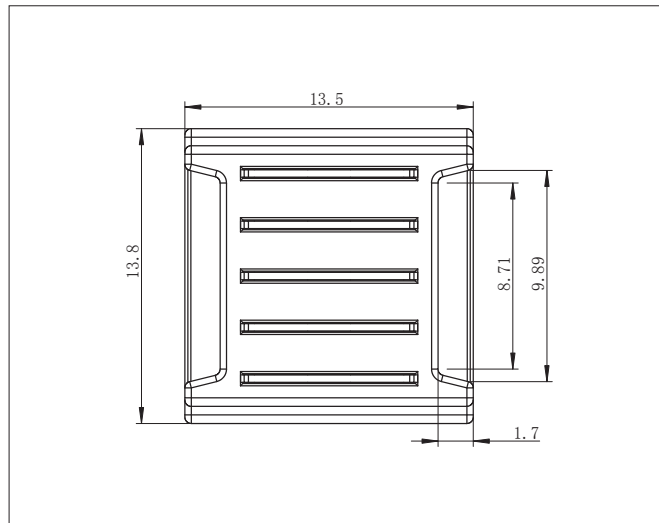

PRODUKT

| | |
|------------------|----------------------------|
| Strøm | 3A maks. pr. farge |
| Volt | 12V / 24V / 48V DC |
| Driftstemperatur | -20°C - +80°C |
| Kompatibel med | IP20 SMD RGBW |
| PCB | 12mm |
| Materiale | Polykarbonat (transparent) |

IP20 RGBW



MONTASJE

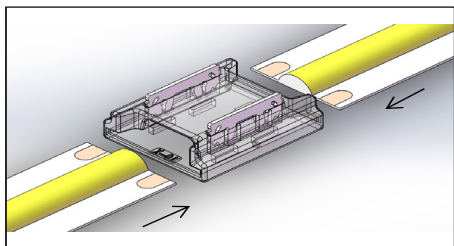

Skv endene på LED-stripene som skal skjøtes sammen inn i skjøtestykket. Sørg for at RGBW på LED-strip er lik på hver side.

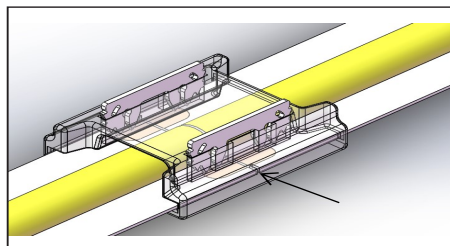

Sørg for at LED-stripene møtes på midten av skjøtestykket.

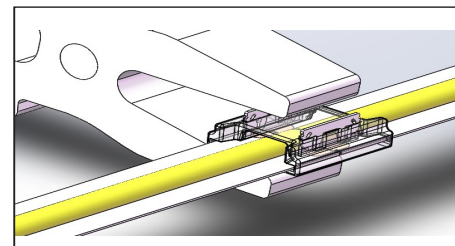

Benytt spesialtilpasset nebbtang til å presse ned metallklemmene. Press jevnt ned og ta en side om gangen.

NB! Ta av tape på undersiden av LED-strip før de føres inn i skjøtestykket.