



Bento 12 LEDS

LedsC4 Team

Low voltage Bento 12 LEDS 12W 3000K CRI 92 DALI-2 Black 1205lm

Technical features

- Luminaire total power: 12W
- Real lumens: 1326
- Real lm/W: 111
- Correlated Colour Temperature (CCT): 3000K
- Lens / reflector angle: FLOOD 47°
- UGR: <=16
- Structure material: Aluminium, Polycarbonate
- Structure finish: Black
- Equipment necessary but not included
- Voltage / frequency: 48VDC
- Dimming protocol: DALI-2
- Power Factor: NULL
- Useful life: 50,000h L80B20
- Warranty: 5 years



Luminotechnic features

- Luminance C0°G65°: 66
- Luminance C90°G65°: 42
- CRI: 92
- MacAdam steps: 3
- Photobiological risk: RG1

UGR		Lampholder	Quantity	Light source power (W)	Correlated Colour Temperature (CCT)
S=0.250					
Ceiling / cavity	0.7	LED	1	12W	3000K
Walls	0.5				
Working Plane	0.2				
Room dimensions	X=4H, Y=8H				
UGR crosswise	11.1				
UGR lengthwise	13.3				

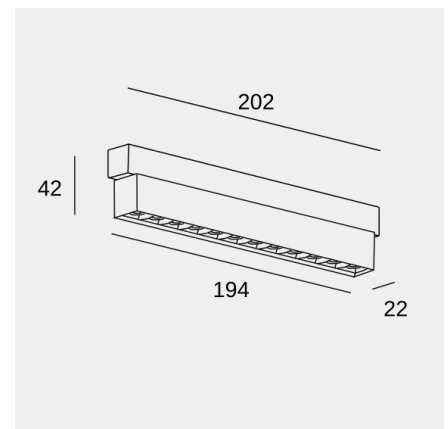

Image may not match reference. LedsC4 reserves the right to amend any of the product's components. The data related to flux, power and colour temperature may be subject to changes made by the manufacturer.



Bento 12 LEDS

LedsC4 Team

Low voltage Bento 12 LEDS 12W 3000K CRI 92 DALI-2 Black 1205lm

Emergency module features

Emergency driver brand: HEP

Logistics

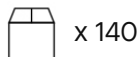

x 140

Net weight (kg): 0.14

Packaged weight (kg): 0.18

Packaging: 55mm x 30mm x 205mm

Image may not match reference. LedsC4 reserves the right to amend any of the product's components. The data related to flux, power and colour temperature may be subject to changes made by the manufacturer.