

# ZAVA

OFFICINE ITALIANE DESIGN

ISTRUZIONI DI MONTAGGIO  
ASSEMBLY INSTRUCTION

## Andromeda

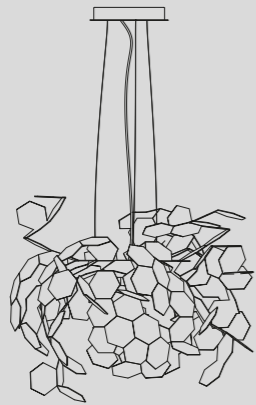

### ATTENZIONE

1. Prima di procedere con l'installazione dell'apparecchio e comunque prima di ogni operazione di manutenzione togliere la tensione di rete.
2. Se il cavo flessibile esterno di questo apparecchio viene danneggiato, deve essere sostituito esclusivamente dal costruttore, dal suo servizio di assistenza o dal personale qualificato, al fine di evitare pericoli.

### WARNING

1. Always unplug the appliance from the power socket before beginning installation or any sort of maintenance work.
2. If the power lead to the appliance is damaged in any way, it must only be replaced by the manufacturer, an authorised service centre or a qualified electrician to prevent any sort of risk for the user.



La marcatura indica che sono state superate positivamente tutte le prove previste dalle normative per la sicurezza elettrica richieste dalla Comunità Europea. Normative EN 60598-1 corrispondenti alle norme italiane per la sicurezza elettrica CEI 34-21.  
This mark guarantees that the product has passed all the test established for electrical safety standards by the European Community. EN 60598-1 corresponding to Italian standards for electrical safety CEI 34-21.



Apparecchio di classe I (la sicurezza viene garantita con la messa a terra).  
Equipment Class I (safety is ensured by connecting the fitting to the ground)



Simbolo che identifica la classificazione secondo il grado di protezione contro la penetrazione di polvere, di corpi solidi e di umidità.  
Index protection. A symbol that identifies the protection index against dust, solid particles or damp entering the fixture.



Questo prodotto deve essere smaltito in modo differenziato dai rifiuti urbani. Non trattare il prodotto come rifiuto ordinario.  
This product should be disposed separately from normal urban rubbish. It may not be treated as household waste.



### Sorgente luminosa / Light source:

Attacco E27 (lampadina esclusa), 100 - 240v, 50-60hz, Max 100w  
Lampholder E27 (bulb not included), 100 - 240v, 50-60hz, Max 100w

CUSTOMER SERVICE  
Zava S.r.l.  
Via Padova 48 - 31041 Cornuda (TV) Italy  
T. +39.0423.639907 F. +39.0423.821639

1

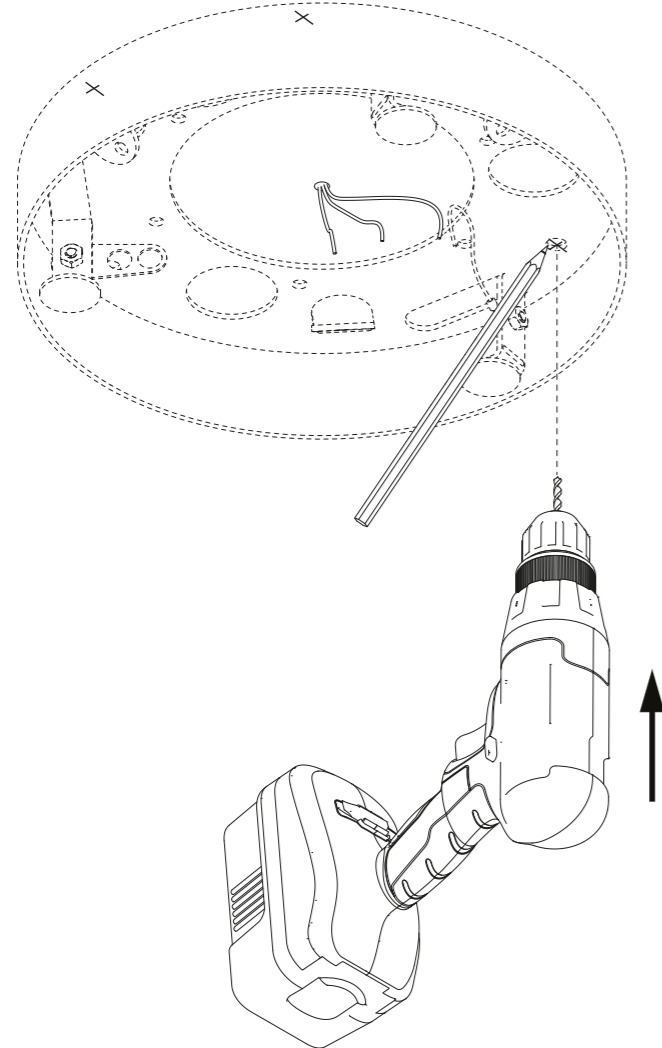

2

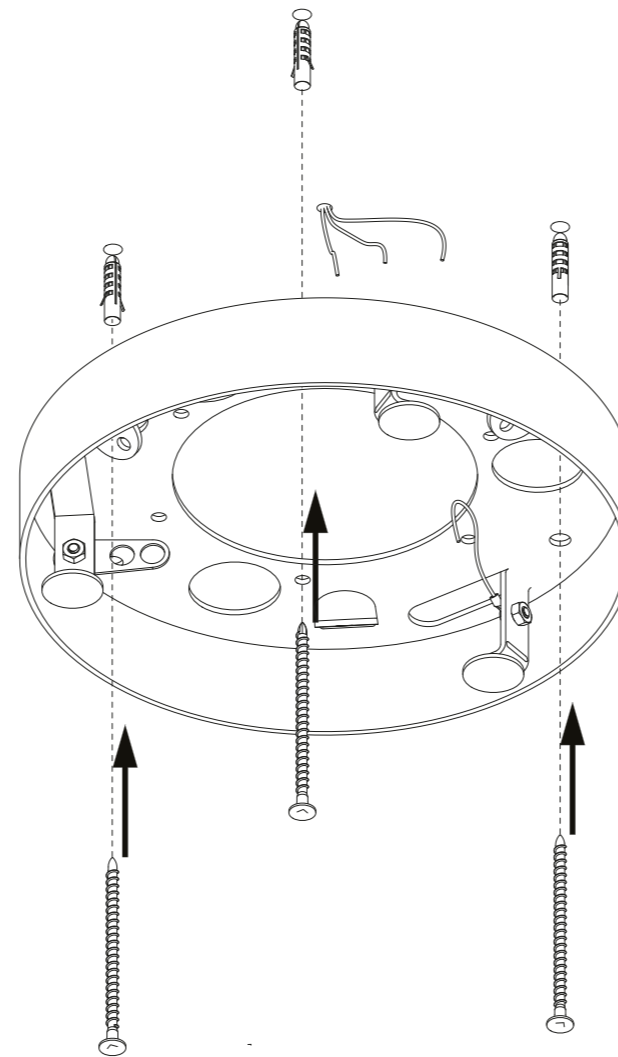

3

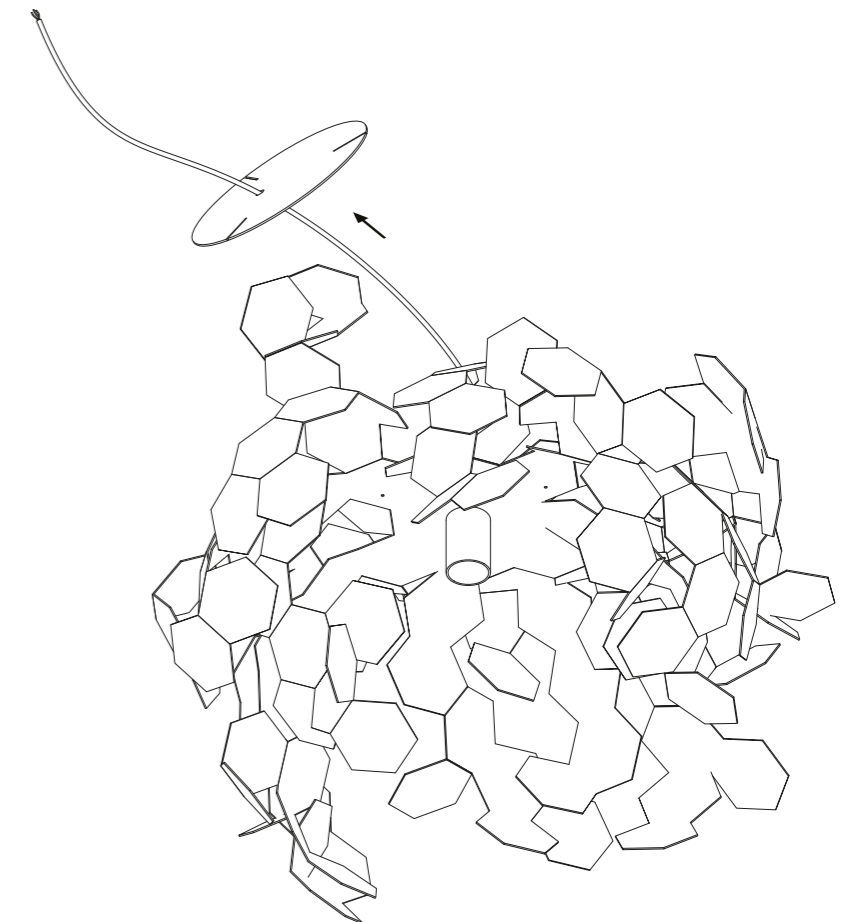

4

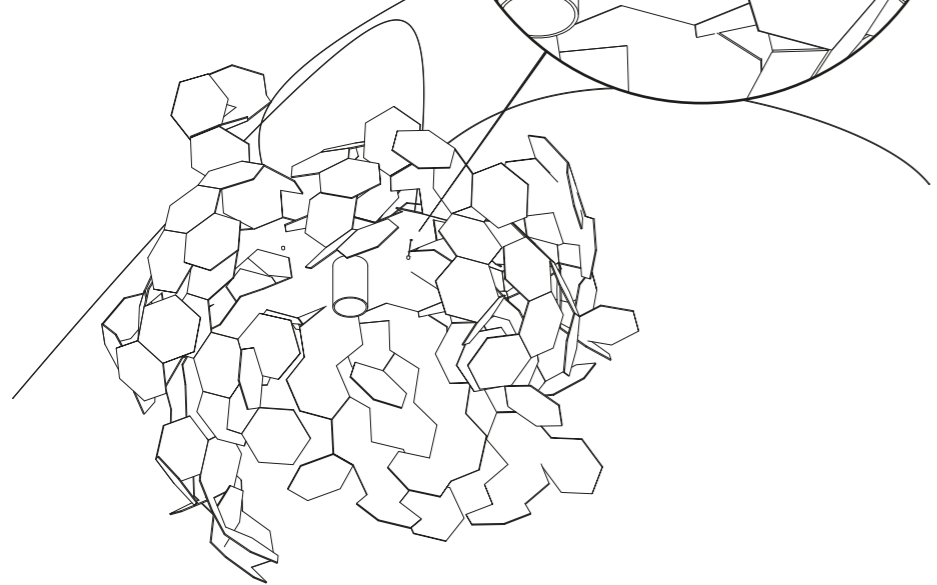
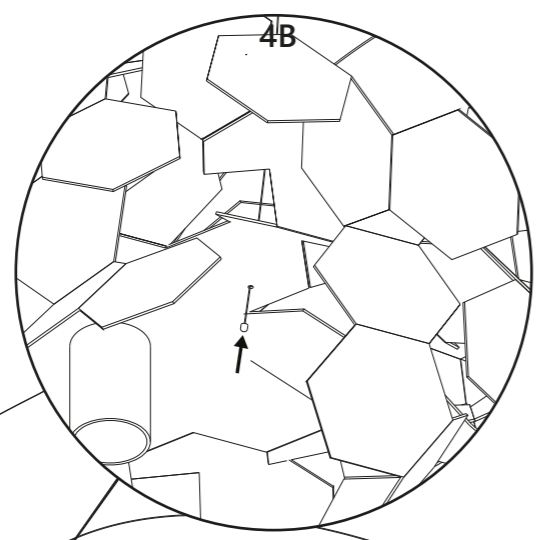

6

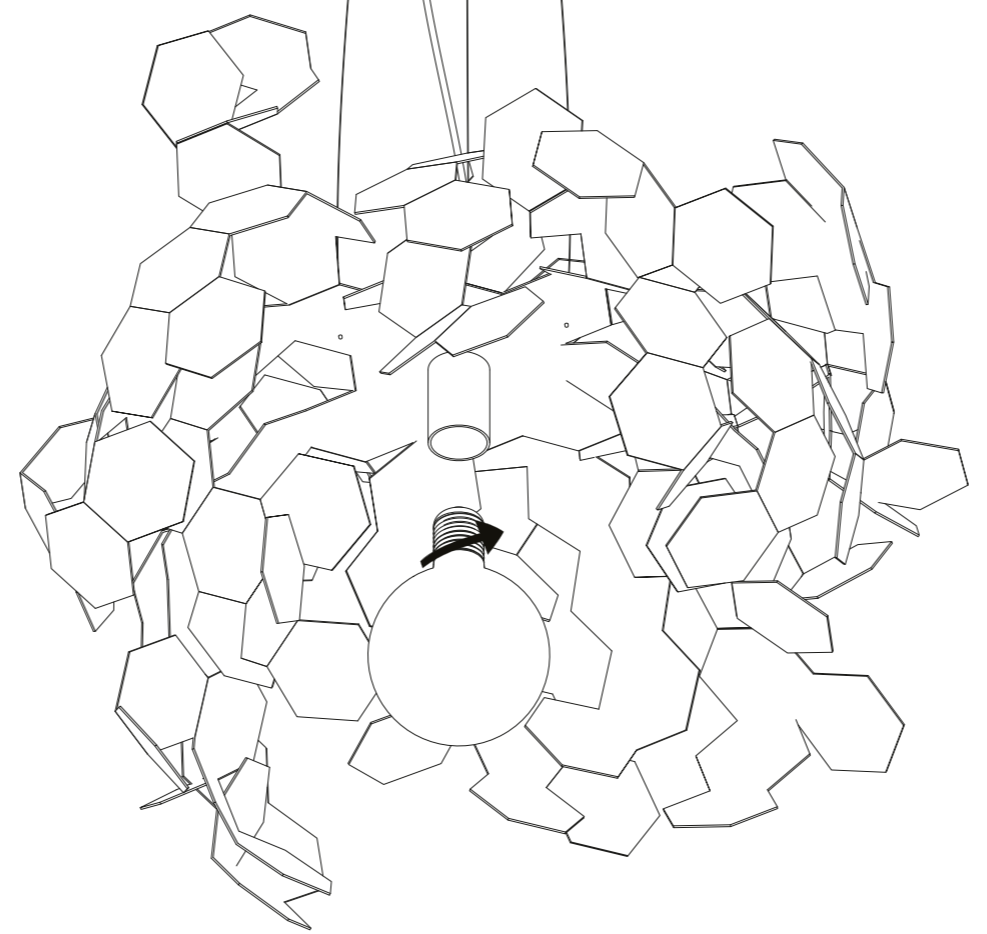
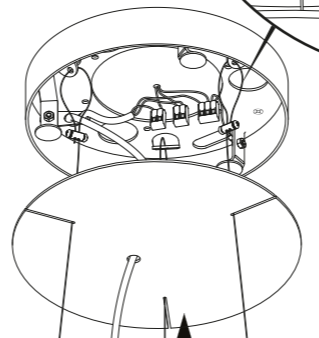
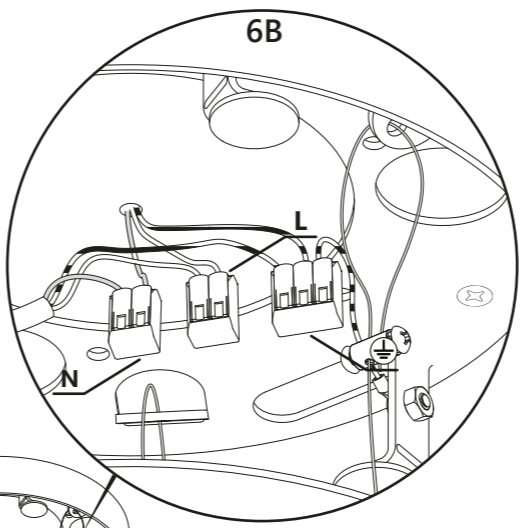

5

