



71-E052-Z5-Z5

V0

Accessory Accessory

Designer: No

Description

Accessory for outdoor use.

Structure material: Galvanized steel. Structure finish: Urban grey. UV protection. Warranty: 5 Years.

Finish

Urban grey

Material

Galvanized steel

TECHNICAL CHARACTERISTICS

Luminaire

Recessed: No
Seaside: No
Uv Protection: Yes
Warranty: 5 Years

Logistics

Energy Efficiency: NA
EAN Code: 8435526867172
Net Weight (Kg): 0.000

The photograph may not match the reference exactly. Please read the product description to identify the finish.

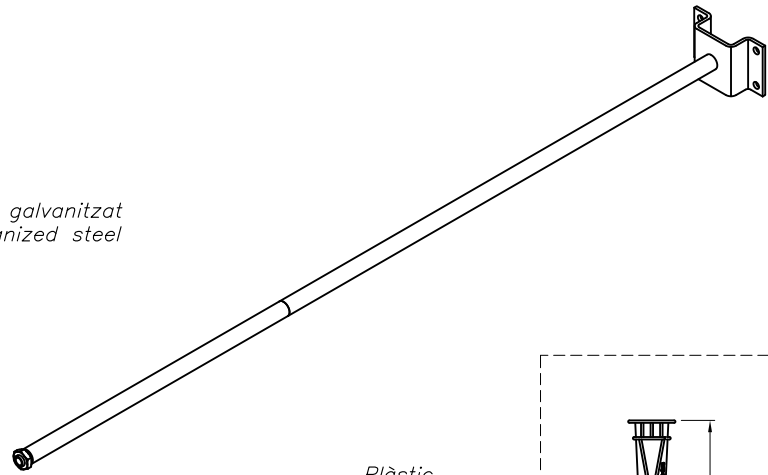
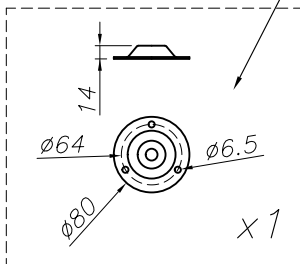
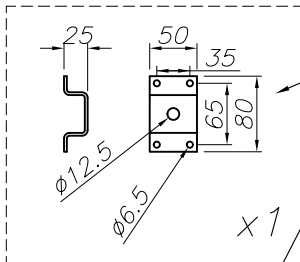
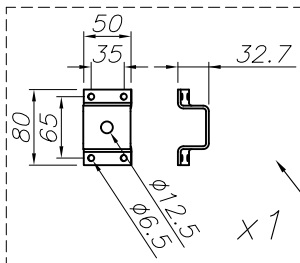
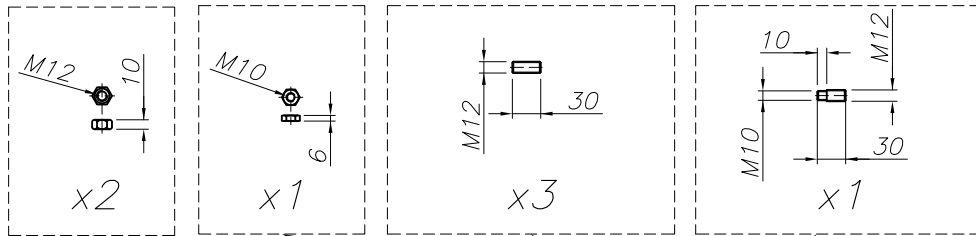
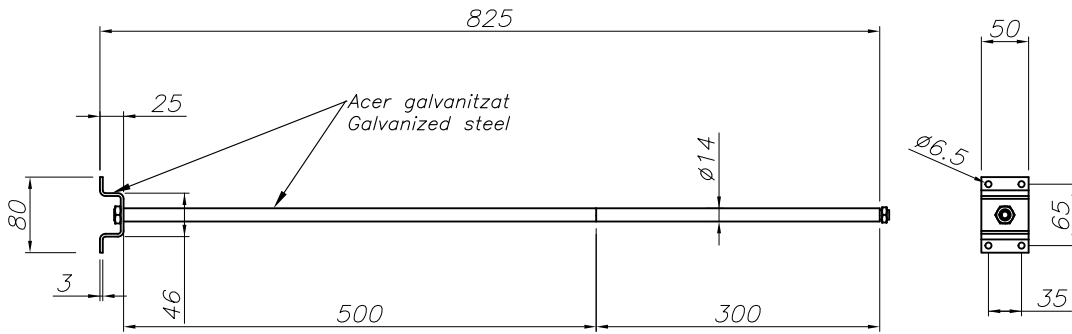

Lenght configuration

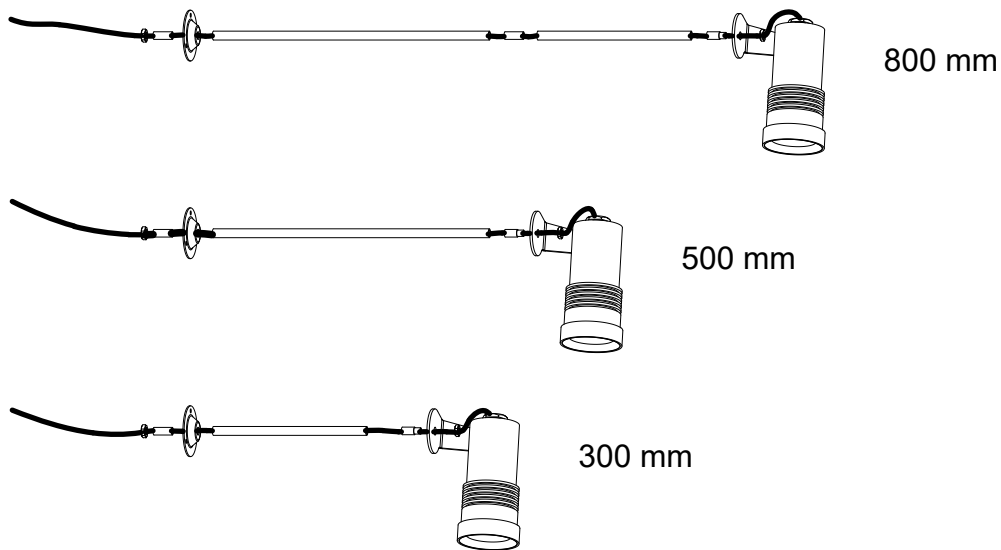

A Flat base

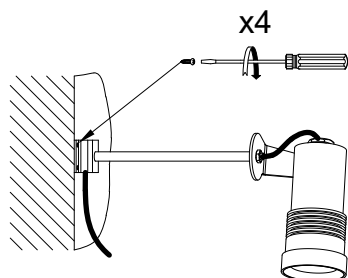

B Base 10°

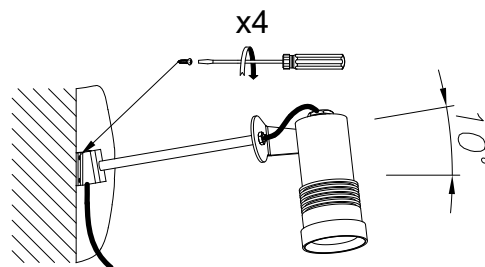

C Circular base

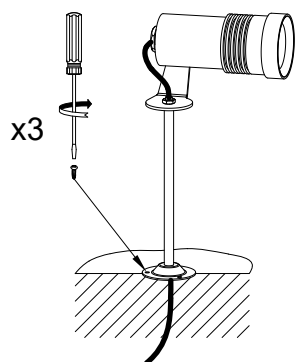

D Spike

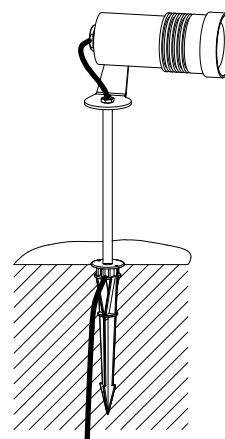



Accessory

71-E052-Z5-Z5

Accessory for outdoor use.

Structure material: Galvanized steel. Structure finish: Urban grey. UV protection. Warranty: 5 Years.

Product net weight (Kg): 0.000

Product length (mm): 830

Product width or diameter (mm): 80

Product height (mm): 80

Gear included: No.