



CUBE PRO MINI LED FLOODLIGHT	POWER	INPUT VOLT.	CONTROL	PIXEL	CHANNEL	kg
	8W	24V DC	ON/OFF	-	-	0.26
NOTE:						



WARNING

ANY MODIFICATION TO THIS LUMINAIRE IS FORBIDDEN WITHOUT PRIOR AUTHORIZATION

Our policy is the constant improvement of the product, we reserve the right to modify the characteristics of the product without prior notice. Please refer to our website www.nordesign.no for this and other technical documents continually updated. All information is presented in good faith, no responsibility may be imputed to us for errors, omissions or incorrect interpretations. The photographs and drawing are within the limits of the quality of the printed reproduction, not binding and indicative only.



This marking indicates that this product should not be disposed with other household wastes throughout the EU. To prevent possible harm to the environment or human health from uncontrolled waste disposal, recycle it responsibly to promote the sustainable reuse of material resources. To return your used device, please use the return and collection systems or contact the retailer where the product was purchased, they can take this product for environmental safe recycling.



Always disconnect the power supply before installing the luminaire or performing maintenance on it.



Risk group 1. Do not stare at the operating lighting source.

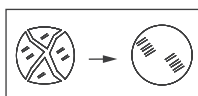

Replace any cracked shield.

DIMENSION DRAWINGS:

Unit: mm

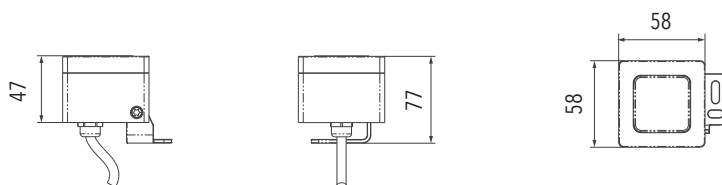

INSTALLATION:

- 1** Secure bracket to supporting surface using screws and dowel suitable for the mounting surface.

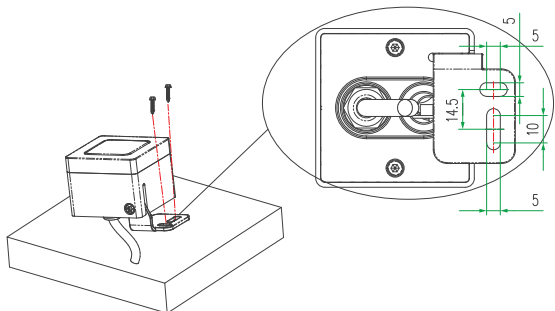

- 2** Adjust orientation as the needs of project, loosen screw to adjust and tight back again when done.

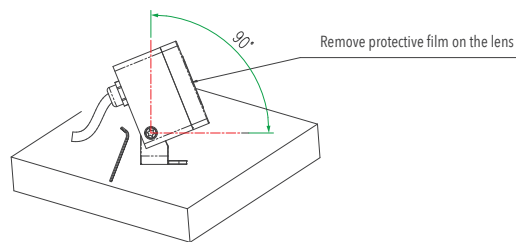

- 3** Connect luminaire to the constant voltage power supply, wiring should be done in waterproof junction box.

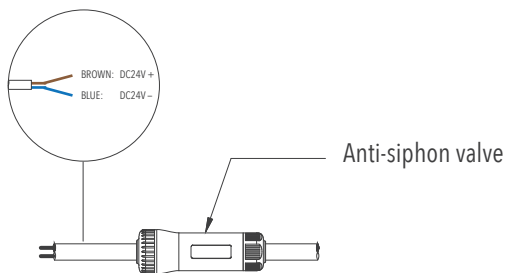

Power input cable with open-end (STANDARD)

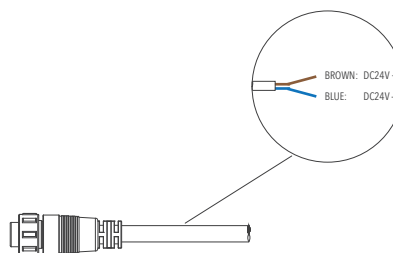

Power input cable with 2-pin male connector (OPTIONAL)

LUMINAIRE CONNECTION:

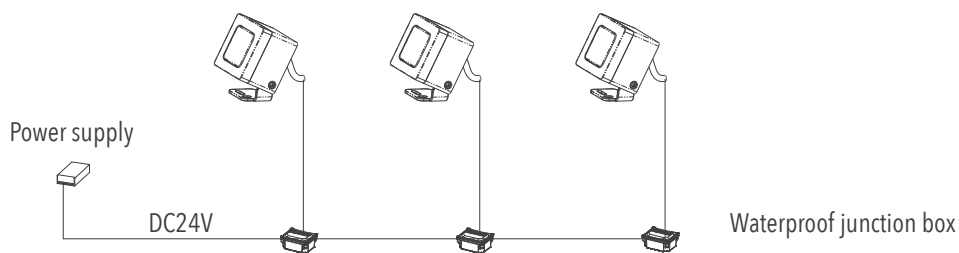

1. The individual luminaires must be connected in parallel
2. Do not cut anti-siphon valve or connector, otherwise warranty will be Invalid



1. The safety and proper functioning of the luminaire is guaranteed only respecting the electrical standards and these installation instructions, therefore it's necessary to conserve in a safe place
2. Installation and maintenance should be operated by a qualified electrician. Always refer to electrical data on the luminaire label
3. Unauthorized alterations to or tampering with the luminaire will invalidate the warranty