

KVG-DHL Series 150W

Whole Family: KVG-XXXXX-DHL 12V/ 24VDC - [30W 60W 80W 96W 100W 120W 150W]



RoHS



Features

Output:	Constant Voltage
Range:	200-240VAC
PFC design:	Built-in active PFC function
Efficiency:	Up to 89%
Protections:	Short circuit/ over load/ over temperature
Heat dissipation:	Cooling by free air convection
Waterproof performance:	IP66
Dimming function:	Phase dimming: work with forward phase /leading edge, MLV and Reverse phase /trailing edge, ELV, TRIAC dimmers 0-10V dimming: 0-10V/1-10V/Potentiometer/10V PWM 4 in 1
Dimming range:	0-100%
PWM frequency	20K Hz
Application:	Suitable for LED lighting and moving sign applications
Warranty:	5 years warranty

Triac/0-10V/1-10V/Potentiometer/10V PWM 5 in 1 Dimmable LED driver 150W

Specification

Model		KVG-12150-DHL	KVG-24150-DHL
Certificate		SAA, ENEC, CE, RoHS, Reach	
Output	DC Voltage	12V	24V
	Voltage Tolerance	±0.5V	
	Voltage Regulation	±0.5%	
	Rated current	12.5A	6.25A
	Rated power	150W	
	Load Regulation	± 2%	
Input	Voltage Range	200-240VAC	
	Frequency Range	47 - 63Hz	
	Power Factor (Typ.) @ full load	PF≥0.99@230VAC	
	THD(Typ.) @ full load	<10%	
	Efficiency(Typ.) @ full load	88%	89%
	AC Current (Max.)	0.8A	
	Inrush Current (Typ.)	72A, 116us@50%230VAC	
	Leakage current	<0.5mA	
Protection	Short Circuit	Shut down o/p voltage, recovers automatically after fault condition is removed	
	Over Load	≤120% Hiccup mode, recovers automatically after fault condition is removed	
	Over temperature	100℃±10℃ shut down o/p voltage, automatically recover after cooling	
Environment	Working TEMP.	-40~+60℃ (see below derating curve)	
	Working Humidity	20 - 95%RH non-condensing	
	Storage TEM., Humidity	-40 - +80℃, 10 - 95% RH non-condensing	
	TEMP. coefficient	±0.03%/℃(0 - 50℃)	
	Vibration	10~500Hz, 5G 10min./1 cycle, period for 60min. each along X, Y, Z axes	
Safety & EMC	Safety standards	EN61347-1 EN61347-2-13 EN62493	
	Withstand voltage	I/P-O/P: 3.75KVAC I/P-FG: 1.88KVAC O/P-FG: 0.5KVAC	
	Isolation resistance	I/P-O/P: 100MΩ/ 500VDC/ 25℃/ 70%RH	
	EMC Emission	EN55015 EN61000-3-2 EN61000-3-3 EN61547	
Others	Net Weight	0.62KG	
	Dimension	368.6*32*23mm(L*W*H)	
	Packing	395*255*170mm 30pcs /CTN G.W.: 20.3KG/CTN	
Notes	<ol style="list-style-type: none"> All parameters NOT specially mentioned are measured at rated load and 25℃ of ambient temperature. Tolerance: includes set up tolerance and load regulation . 		

Triac/0-10V/1-10V/Potentiometer/10V PWM 5 in 1 Dimmable LED driver 150W

Efficiency Curve (efficiency vs output load)

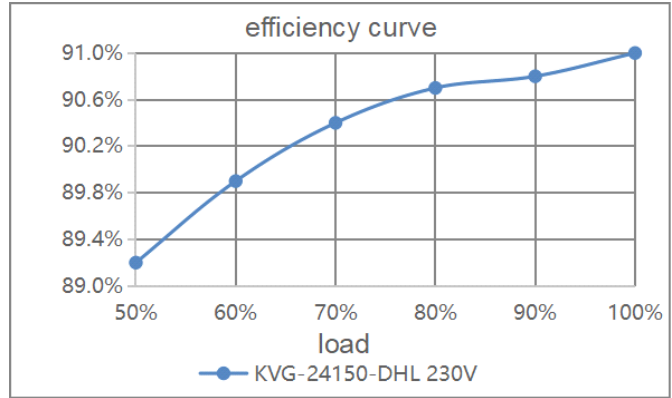
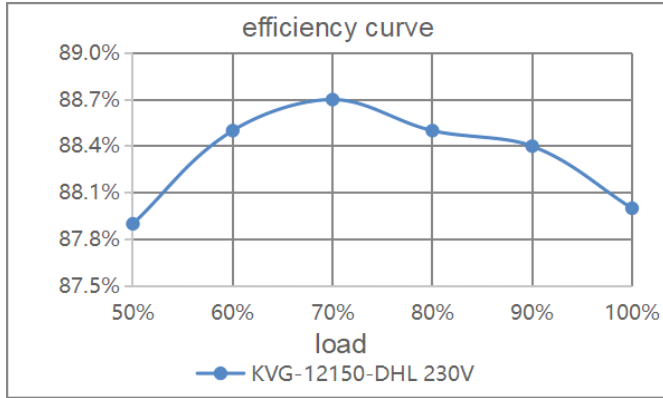

Derating Curve (output load vs TEMP.)

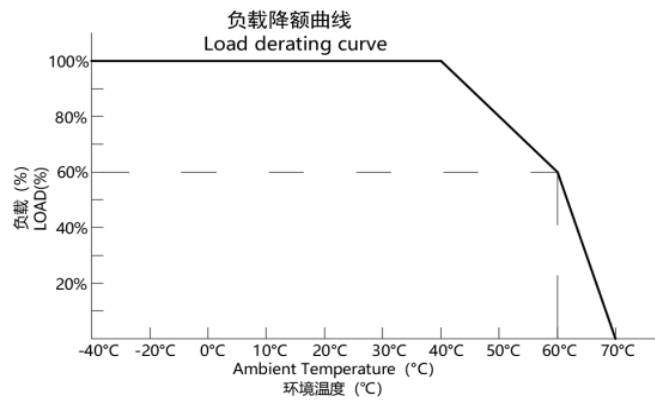

❖ To extend their life, please refer to the Derating Curve and derate according to the temperature.

Power Factor Curve

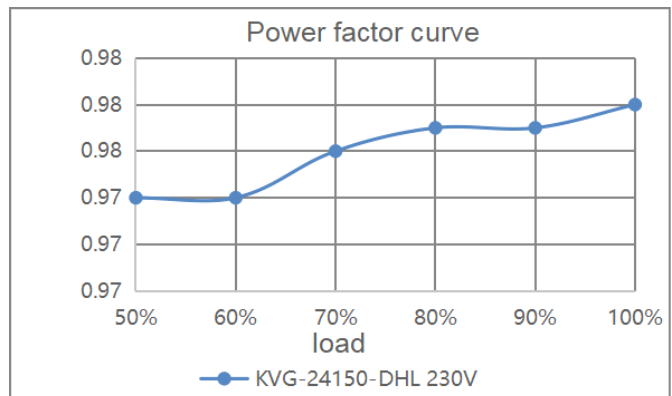
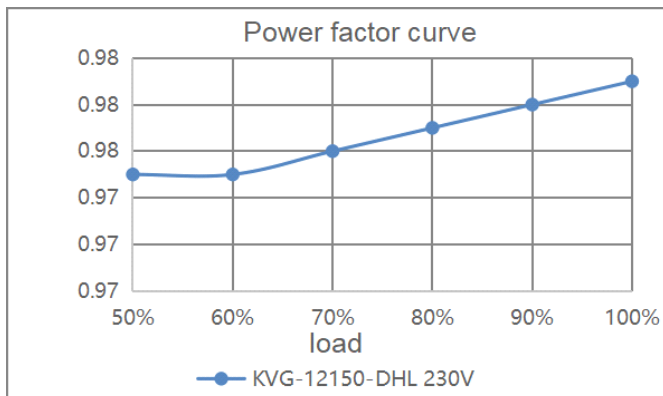

Triac/0-10V/1-10V/Potentiometer/10V PWM 5 in 1 Dimmable LED driver 150W

Mechanical Specification

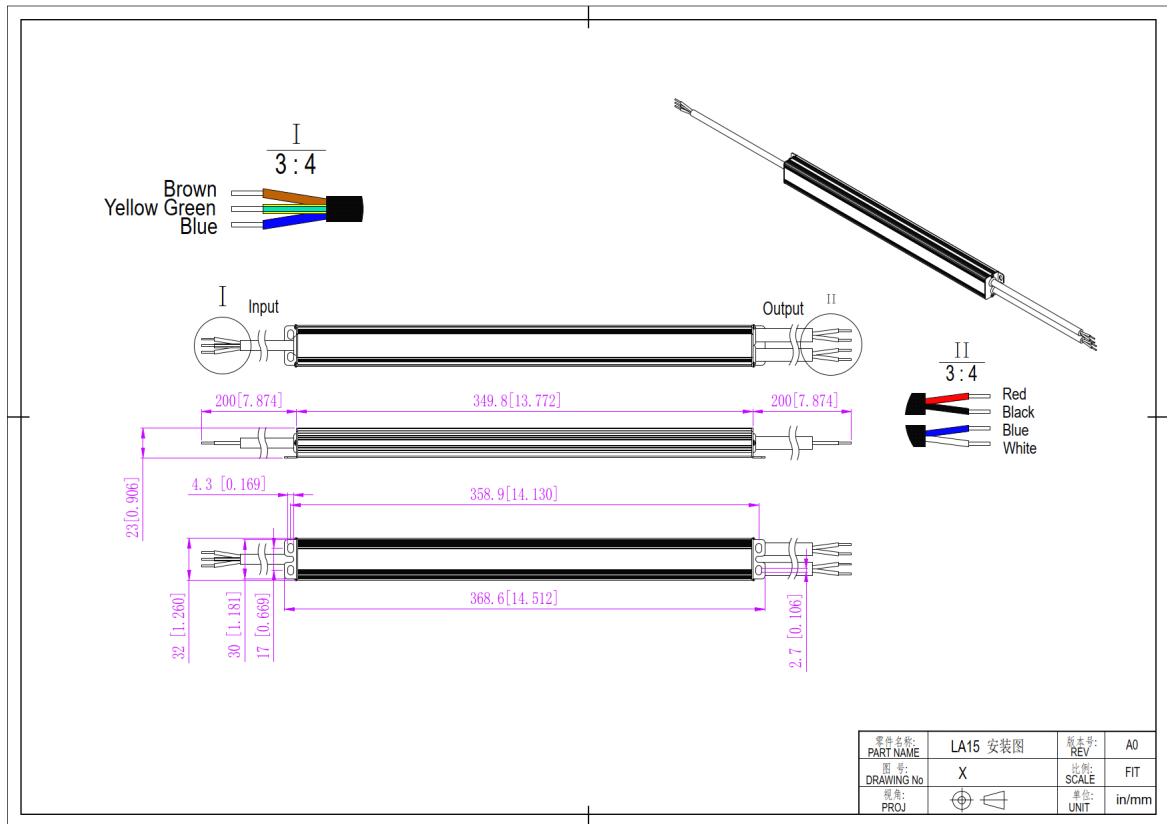

12V&24V Version

1. Input cable 3*1.0 mm²: the green/yellow cable to (FG) “Brown” to L, and “Blue” to N of Mains AC.
2. Output cable 2*1.0 mm²: “Red” (+) to LED Positive side (+) , “Black”(-) to LED Negative side (-).
3. Dimming cable 2*0.75 mm²: “DIM” (+) Blue to 0/1-10V dimmer signal(+),“DIM” (-) white to 0/1-10V dimmer signal (-) .
4. Please DO NOT connect “DIM” (-) to “LED”(-), “DIM” (+) to “LED”(+) , or other incorrect connection.
5. Please make sure your connect these correctly otherwise your product will not function correctly and could be damaged.

Warm tips:

1. Any other requests for , we can customized.

Triac/0-10V/1-10V/Potentiometer/10V PWM 5 in 1 Dimmable LED driver 150W

Dimming Operation and Connecting Diagram

- **Using two ways of dimming at the same time**, you must be assured that LED lighting is up to the max. Brightness then you could operate with the other dimming.

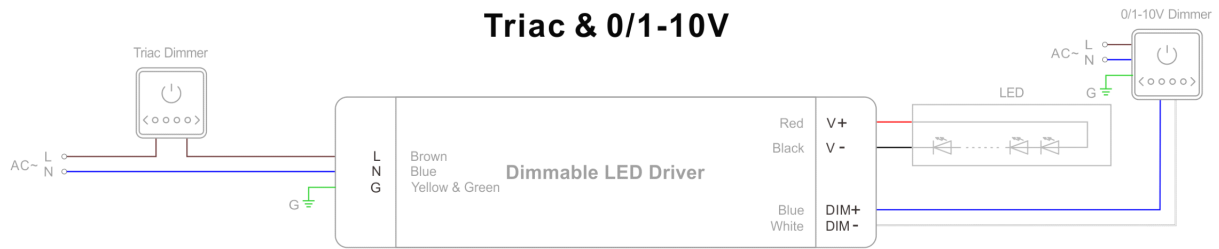

Using one dimming ---TRIAC/Phase cut dimming

1. The Pulse-Width Modulation (PWM) of output voltage can be adjusted through input terminal of the AC phase line(L) by connection a phase /Triac dimmer or lighting system.
2. Working with forward phase /leading edge, MLV and Reverse phase /trailing edge, ELV, TRIAC dimmers or light system.
3. Min. loading is about 10%.
4. Please try to use dimmers with power at least 1.5 times as the output power of the driver.

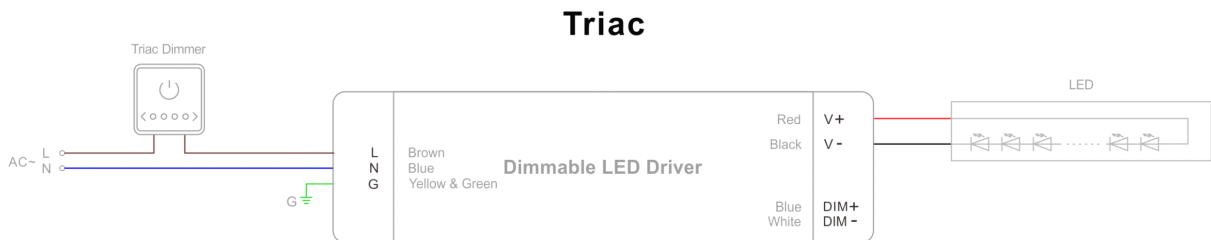

● **Using one dimming ---0-10/ 1-10V/ 10V PWM/ Potentiometer dimming**

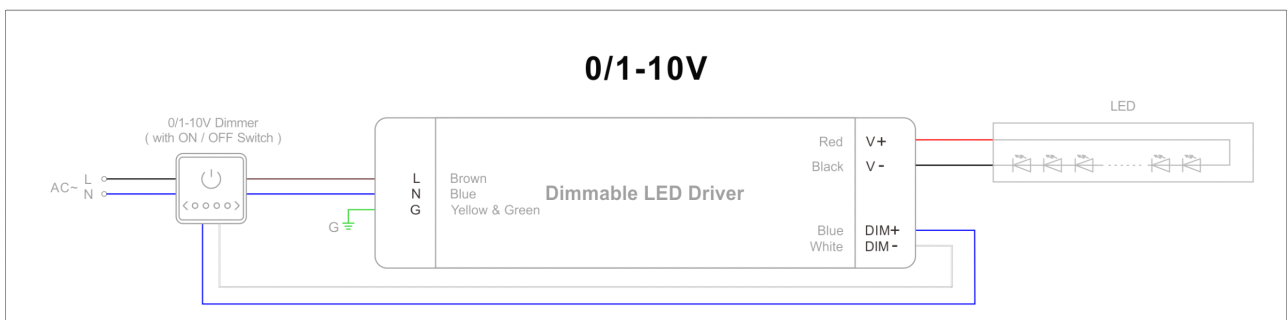

Triac/0-10V/1-10V/Potentiometer/10V PWM 5 in 1 Dimmable LED driver 150W

1-10V / Potentiomete

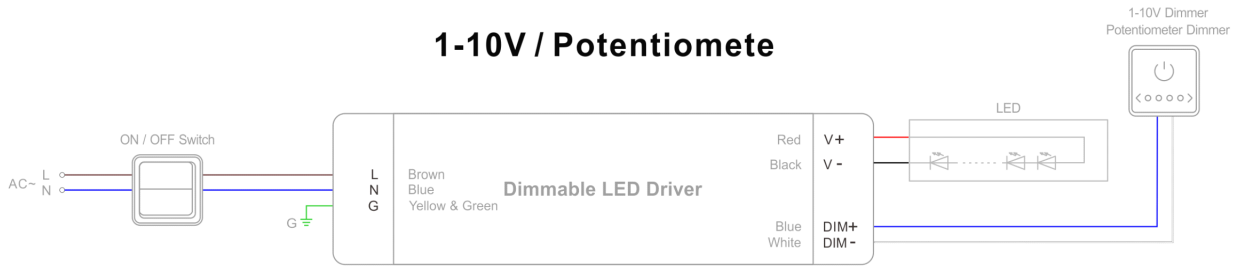

0-10V / 10V PWM

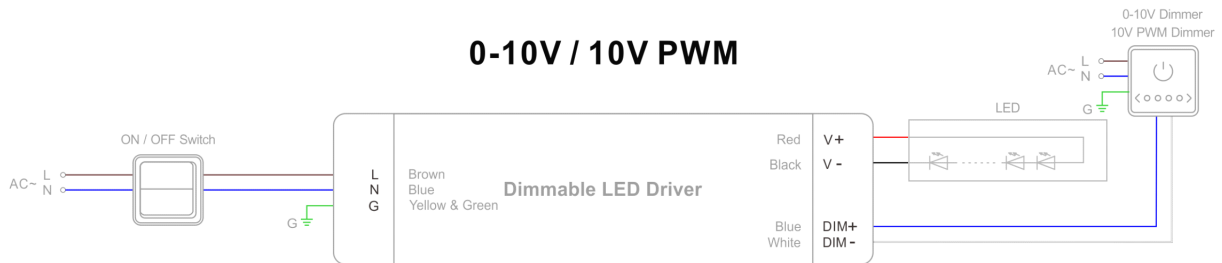

Instruction

1. This driver should be installed by qualified and professional person.
2. Please make sure the driver is installed with adequate ventilation around it to allow for heat dissipation; If the product is installed in a sealed lamp, it is recommended to reduce the load and use it; The recommended load size is $\leq 80\%$ of the rated load.
3. Ensure that wiring is correct before test in order to avoid light and power supply damage.
4. If driver Cannot work normally, don't maintain privately.

Have any questions, please contact Zhuhai Shengchang.

Please visit our website or contact us for more information! www.scpower.net.cn/en.