

KVG-DH Series 60W

Whole Family: KVG-XXXXX-DH 12V/ 24V / 48VDC - [30W 60W 80W 100W 120W 150W 200W 300W 320W 360W]



Features

Output:	Constant Voltage
Range:	200-240VAC
PFC design:	Built-in active PFC function
Efficiency:	Up to 88%
Protections:	Short circuit/ over load/ over temperature
Heat dissipation:	Cooling by free air convection
Waterproof performance:	IP20
Dimming function:	<u>Phase dimming</u> : work with forward phase /leading edge, MLV and Reverse phase /trailing edge, ELV, TRIAC dimmers <u>0-10V dimming</u> : 0-10V/ 1-10V/ Potentiometer/ 10V PWM 4 in 1
Dimming range:	0-100%
PWM frequency:	20K Hz
Application:	Suitable for LED lighting and moving sign applications
Warranty:	5 years warranty

Triac/0-10V/1-10V/Potentiometer/10V PWM 5 in 1 Dimmable LED driver 60W
Specification

Model		KVG-12060-DH	KVG-24060-DH	KVG-48060-DH
Certificate		CE / ROHS / Reach		
Output	DC Voltage	12V	24V	48V
	Adjustable rated voltage range	10V-13V	21.5V-25.5V	48V-50V
	Voltage Tolerance	±0.5V		
	Voltage Regulation	±0.5%		
	Rated current	5A	2.5A	1.25A
	Rated power	60W		
	Load Regulation	±2%	±1%	
Input	Voltage Range	200-240VAC		
	Frequency Range	47 - 63Hz		
	Power Factor (Typ.) @ full load	0.96@230VAC	0.96@230VAC	0.97@230VAC
	THD(Typ.) @ full load	≤20%		
	Efficiency(Typ.) @ full load	88%@230VAC	86%@230VAC	85%@230VAC
	AC Current (Max.)	0.5A		
	Inrush Current (Typ.)	45.2A, 376us @50%Ipeak 80.8A, 186us @50%Ipeak	49.6A, 136us @50%Ipeak	
	Leakage current	<0.5mA		
Protection	Short Circuit	Hiccup mode, re-power on to recover after fault condition removed		
	Over Load	≤120% Hiccup mode,recovers automatically after fault condition is removed		
	Over temperature	100℃±10℃ shut down o/p voltage, automatically recover after cooling		
Environment	Working TEMP.	-40~+70℃ (see below derating curve)		
	Working Humidity	20 - 90%RH non-condensing		
	Storage TEM.,Humidity	-40 - +80℃, 10 - 95% RH non-condensing		
	TEMP.coefficient	±0.03%/℃(0 - 50℃)		
	Vibration	10~500Hz, 2G 10min./1 cycle, period for 60min. each along X,Y,Z axes		
Safety & EMC	Safety standards	EN61347-1; EN61347-2-13		
	Withstand voltage	I/P-O/P:3.75KVAC (EU)		
	Isolation resistance	I/P-O/P:100MΩ/500VDC/25℃/70%RH		
	EMC Emission	EN55015	EN61000-3-2	EN61000-3-3
Others	Net Weight	0.35Kg		
	Dimension	178*61.1*24mm(L*W*H)		
	Packing	290*215*140mm 20pcs /CTN		
Notes	1. All parameters NOT specially mentioned are measured at rated load and 25℃ of ambient temperature. 2. Tolerance: includes set up tolerance and load regulation .			

Triac/0-10V/1-10V/Potentiometer/10V PWM 5 in 1 Dimmable LED driver 60W

Efficiency Curve (efficiency vs output load)

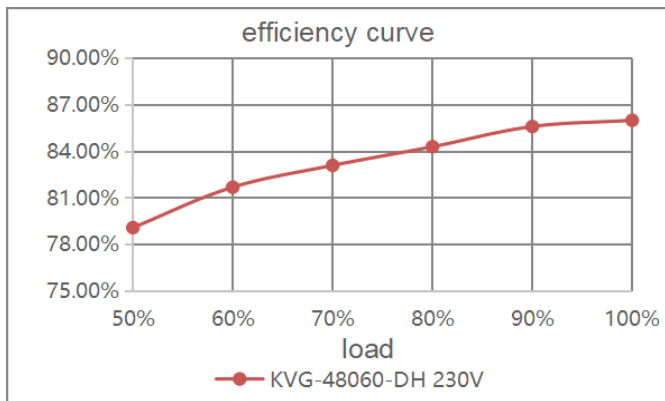
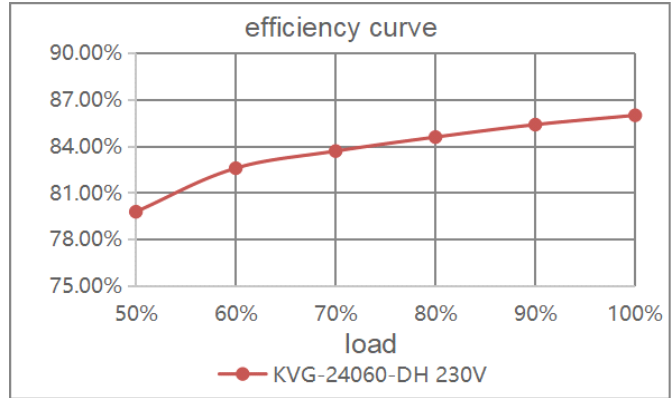
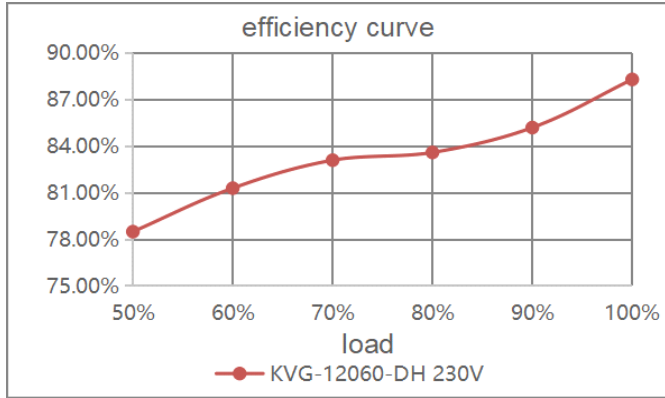

Derating Curve (output load vs TEMP.)

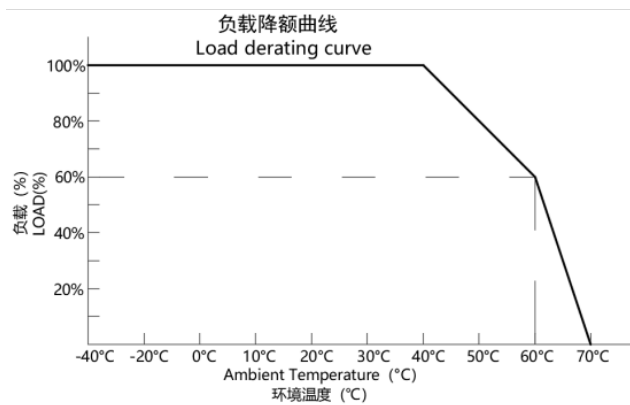

❖ To extend their life, please refer to the Derating Curve and derate according to the temperature.

Triac/0-10V/1-10V/Potentiometer/10V PWM 5 in 1 Dimmable LED driver 60W

Power Factor Curve

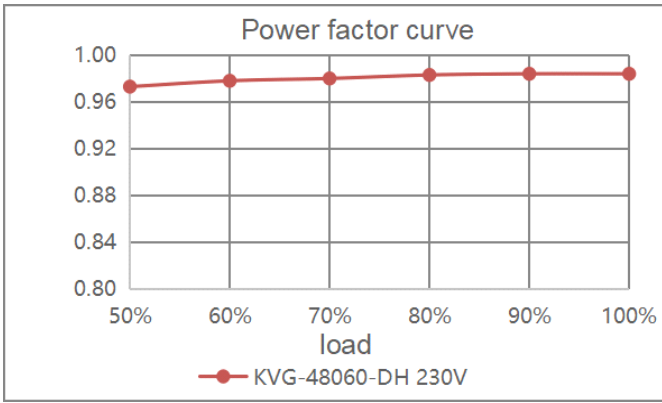
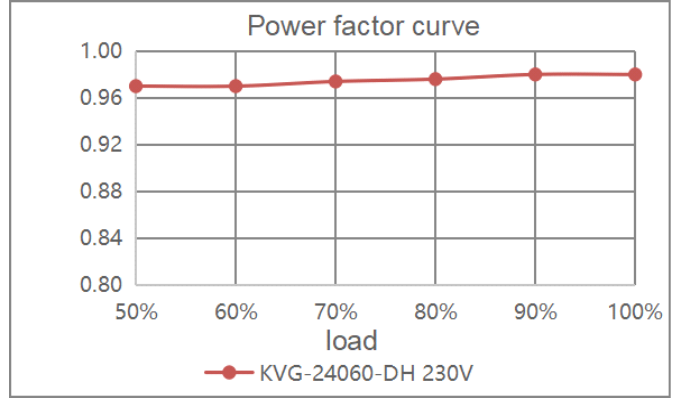
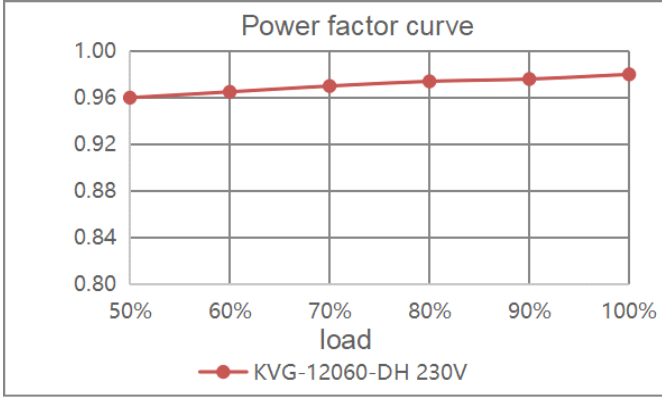

Triac/0-10V/1-10V/Potentiometer/10V PWM 5 in 1 Dimmable LED driver 60W

Mechanical Specification

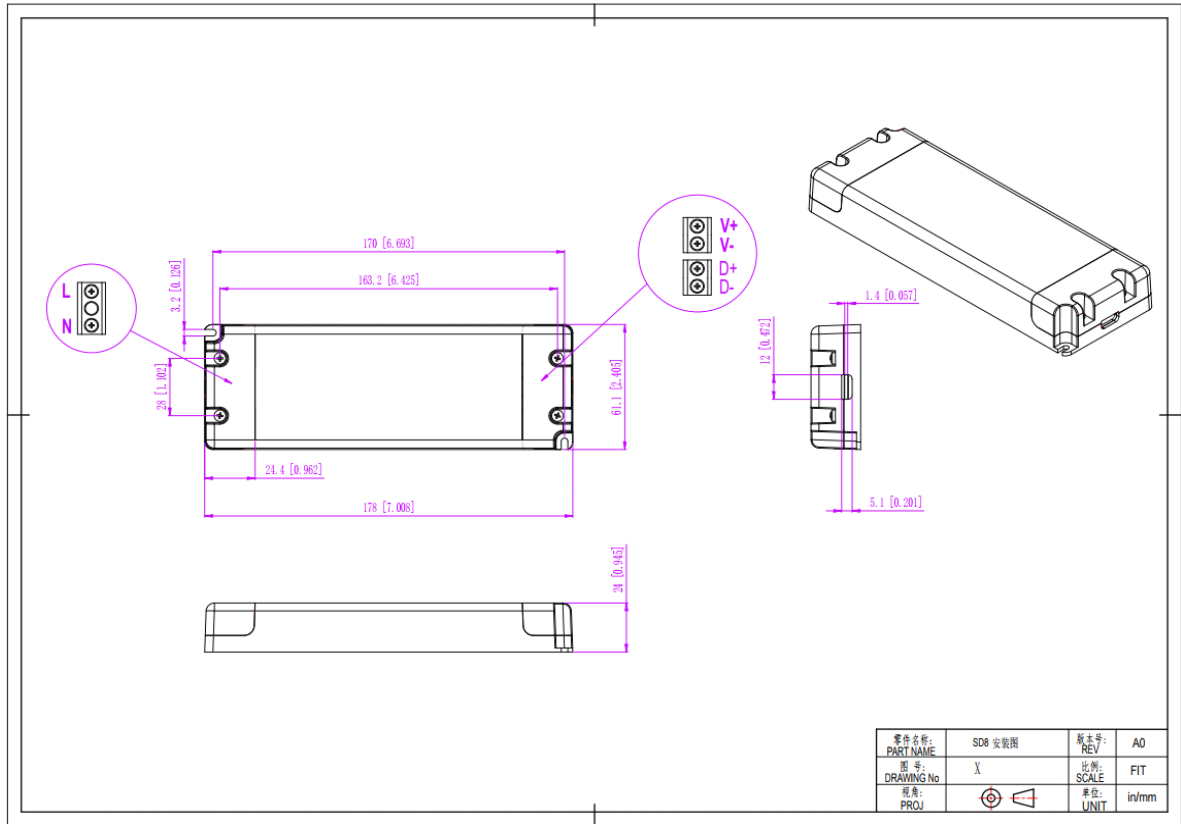

12V&24V&48V Version

1. Input with DG126 terminals 3P: Live Wire AC (L), Neutral Wire AC(N)
2. Output LED SEC with DG126 terminals 2P: output Positive (LED+), output negative (LED-). Connected to LED Lamps.
1. Dimming terminals with DG126 2P: DIM(+) and DIM(-).
2. Please DO NOT connect “DIM-“ to “LED-“, “DIM+“ to “LED+“, or other incorrect connection.
3. Please make sure your connect these correctly otherwise your product will not function correctly and could be damaged.

Warm tips:

1. Suggested wire diameter: Input 0.75-2mm²; Output:0.5-2mm².
2. Any other requests for cable, we can customized.

Triac/0-10V/1-10V/Potentiometer/10V PWM 5 in 1 Dimmable LED driver 60W

Dimming Operation and Connecting Diagram

- **Using two ways of dimming at the same time**, you must be assured that LED lighting is up to the max. Brightness then you could operate with the other dimming;

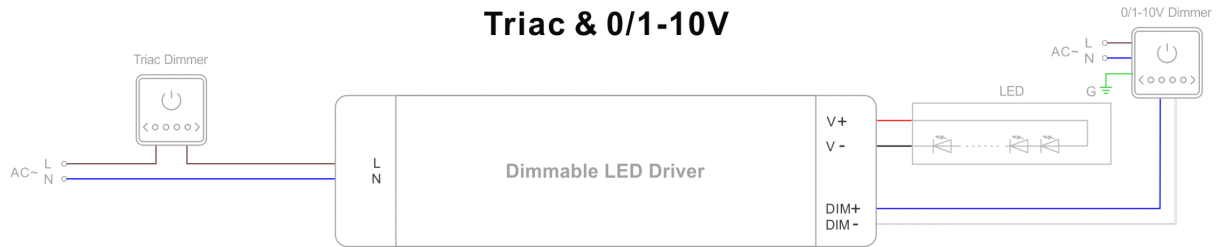

- **Using one dimming ---TRIAC/Phase cut dimming**

1. The Pulse-Width Modulation (PWM) of output voltage can be adjusted through input terminal of the AC phase line(L) by connection a phase /Triac dimmer or lighting system.
2. Working with forward phase /leading edge, MLV and Reverse phase /trailing edge, ELV, TRIAC dimmers or light system.
3. Min. loading is about 10%
4. Please try to use dimmers with power at least 1.5 times as the output power of the driver.

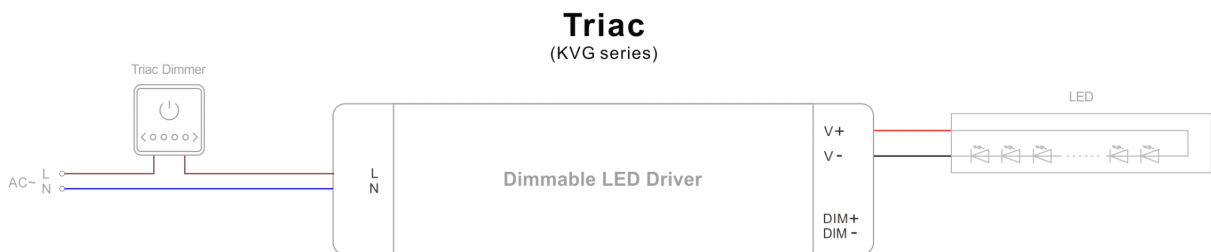

- **Using one dimming ---0-10V/ 1-10V/ 10V PWM/ Potentiometer dimming**

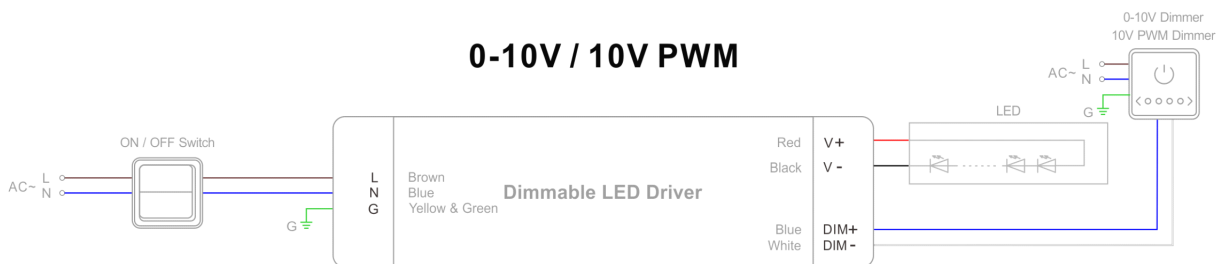

Triac/0-10V/1-10V/Potentiometer/10V PWM 5 in 1 Dimmable LED driver 60W

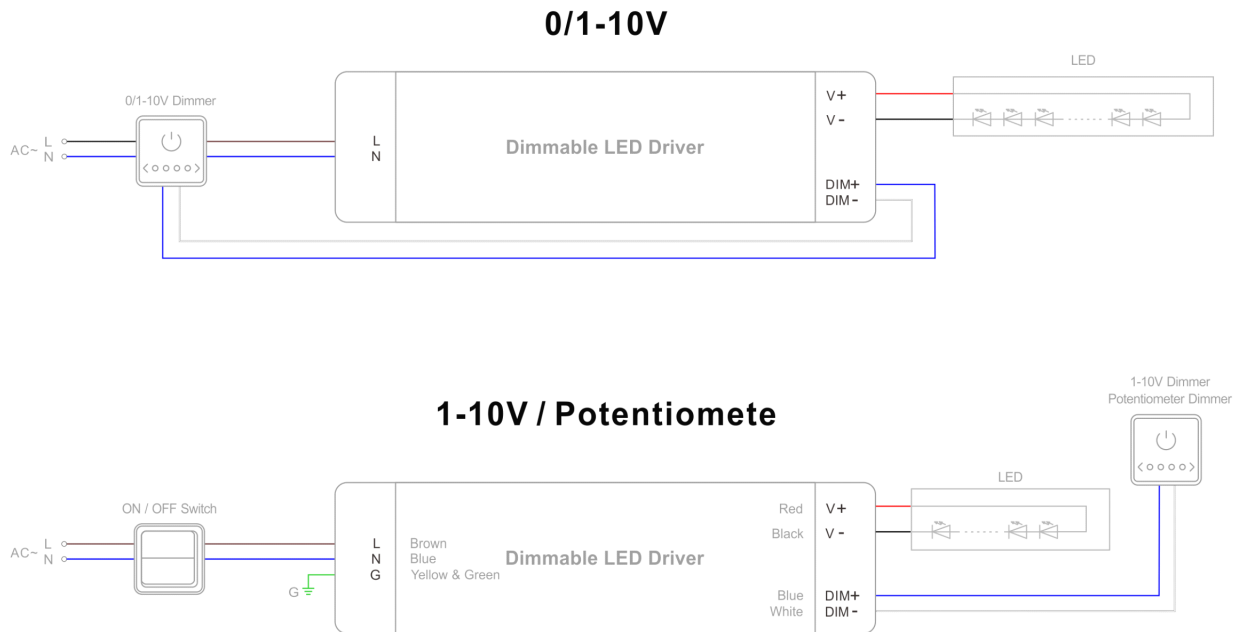

Instruction

1. This driver should be installed by qualified and professional person.
2. Please make sure the driver is installed with adequate ventilation around it to allow for heat dissipation.
3. Ensure that wiring is correct before test in order to avoid light and power supply damage.
4. If driver Cannot work normally, don't maintain privately.

Have any questions, please contact Zhuhai Shengchang.