

SKYLINE

Material List

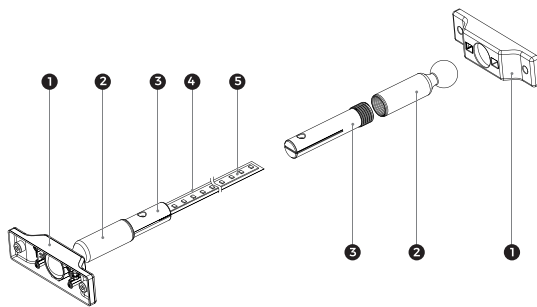

- | | |
|--------------------|----------------------------|
| 1. bottom box * 2 | 7. wire rope * 1 |
| 2. rotary rod * 2 | 8. LED strip installer * 1 |
| 3. screw rod * 2 | 9. slip-proof glove * 1 |
| 4. steel strip * 1 | 10. marker * 1 |
| 5. LED strip * 1 | 11. M3.5*40 screws kit * 4 |
| 6. scissors * 1 | 12. wrench * 1 |

Installation procedure

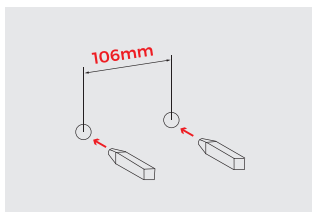

- 1** On the installation wall, drill two $\phi 10$ mm holes with a distance of 106 mm, and install the cork.

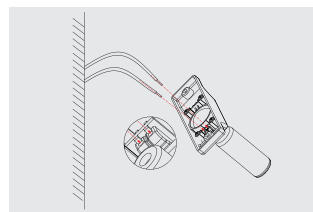

- 2** Connect the DC24V wire to the terminal of the bottom box. The wire is recommended to be 16AWG single copper wire.

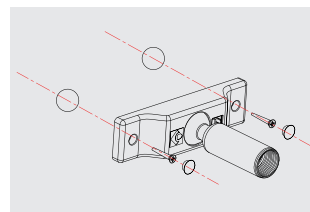

- 3** Put the rotary rod through the bottom box, and fix the bottom box onto the wall. Please fix the rotary rod marked A to the bottom box with terminals.

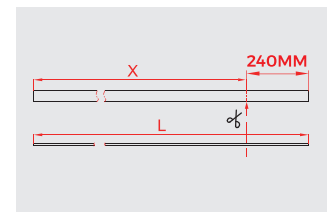

- 4** Measure the distance(L) between the installation walls with wire rope, and the cutting length(X) of the steel strip should be 240mm shorter than L.

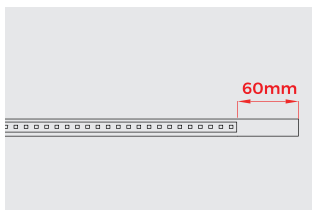

- 5** Paste the LED strip on the steel strip, the beginning position should be 60mm away from one end of the steel strip.

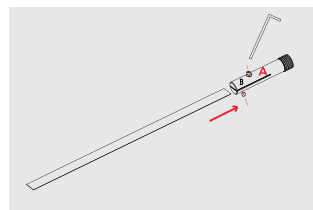

- 6** Fix the steel strip to the screw rod. The steel strip which side with a quick plug terminal should be fixed to the screw rod marked A.

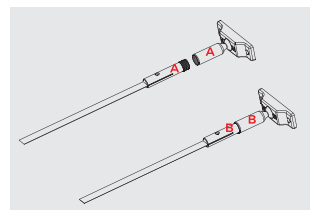

- 7** Fix the screw rod with the rotary rod. Tighten the steel strip by turning the rotary rod.

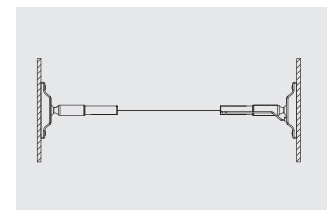

- 8** Plug the quick plug terminal into the bottom box.