

NOR DESIGN

www.nordesign.no

Alyce Module lighting



Alyce Module lighting

Modulbasert armaturserie

Alyce er en modulbasert serie, hvor man velger ønsket modul og kombinerer det med armatur. Velg mellom et stort utvalg ulike moduler og armaturer for utenpåliggende, innfelt og nedhengt montasje.

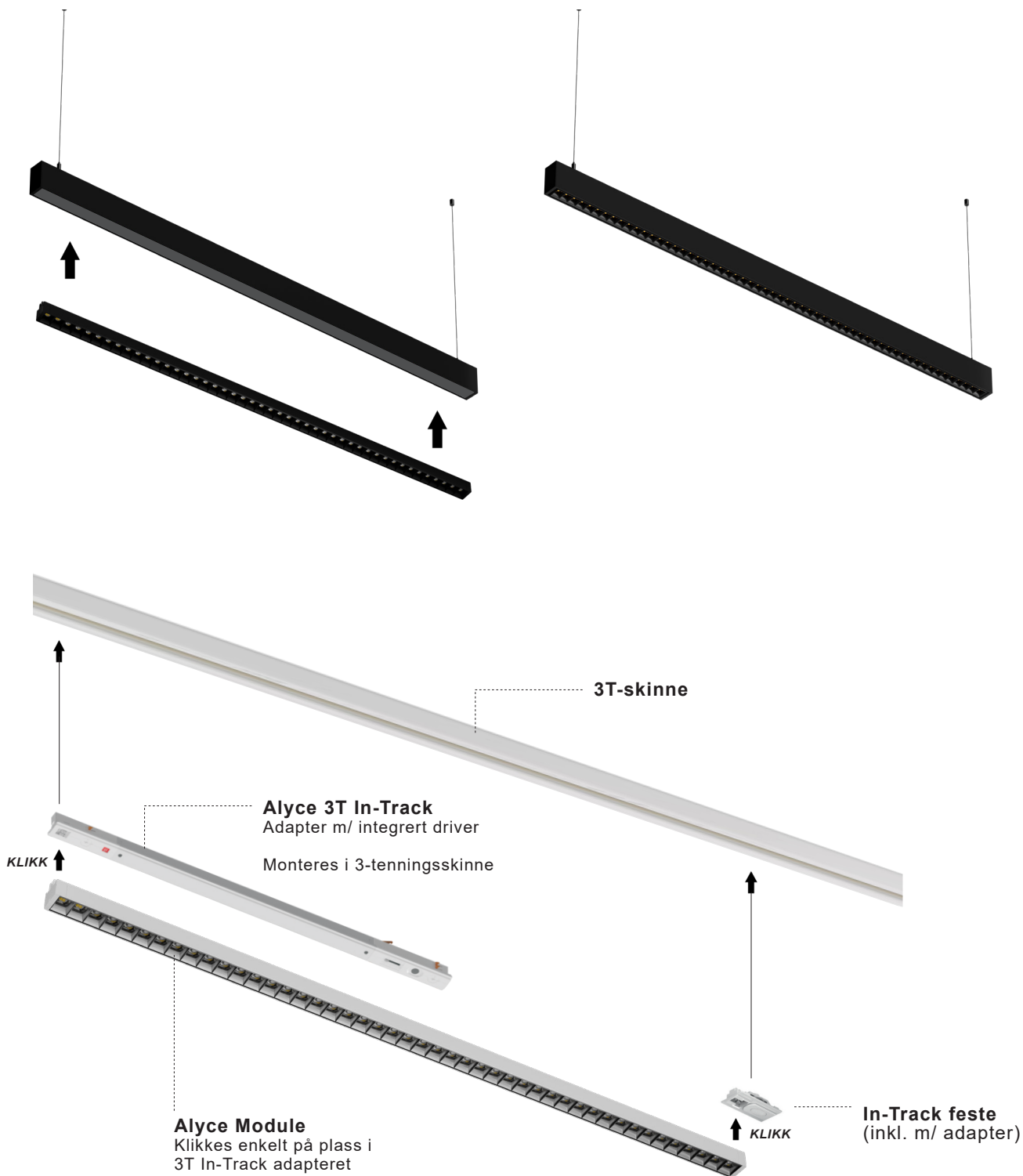

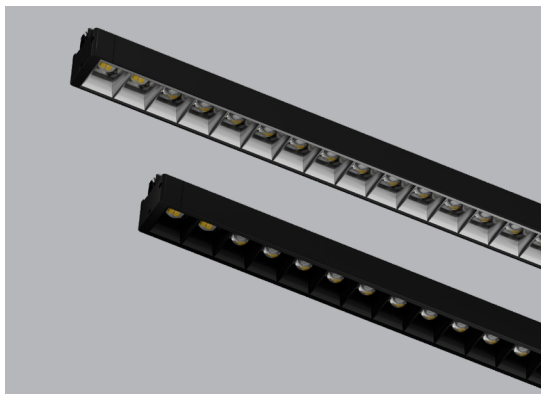

Alyce - Module

S. 4-5

Alyce Module

Modulene kommer i to ulike modeller og i to ulike lengder. Modulene er designet for å gi meget lav blending, hvor man oppnår $UGR < 16$ og $UGR < 19$.

Modulene benyttes enten med 3T In-Track, Hera eller Eos.

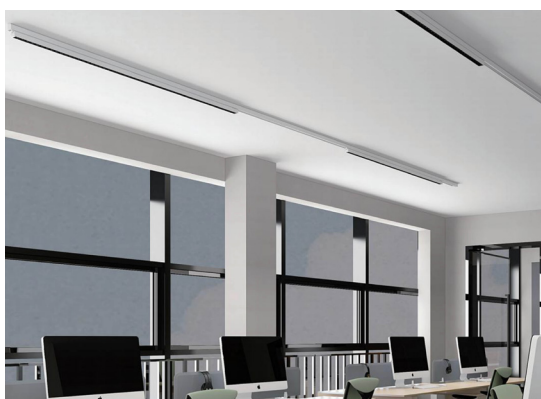

Alyce - 3T In-Track

S. 6-7

Alyce 3T In-Track er et modulbasert system for 3-tenningsskinne

Alyce 3T In-Track driver benyttes sammen med valgt modul og klikkes enkelt på plass i 3-tenningsskinne (Global Trac).

Systemet er meget fleksibelt, hvor man kan plassere lyset hvor som helst på skinnen. Modulene gir meget lav blending - $UGR < 16$ / $UGR < 19$.



Hera - Alyce

S. 8-9

Hera Alyce - Utenpåliggende eller nedhengt

Armaturen benyttes med valgt modul og kan enten monteres utenpåliggende eller nedhengt.

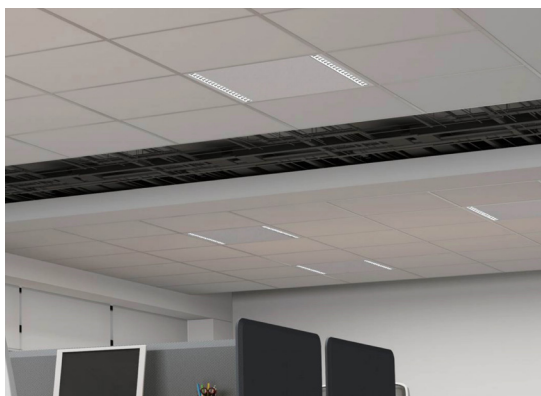

Eos - Alyce

S. 10-11

Eos Alyce - Innfelt armatur for systemhimling

Armaturen er 30x120cm og benyttes med valgt modul.

ALYCE - MODULE R16

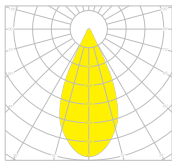

60°

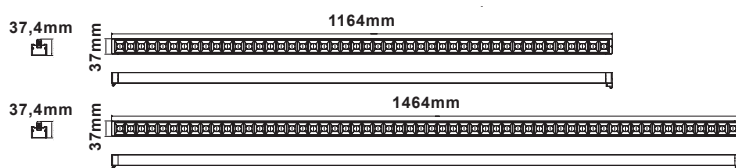
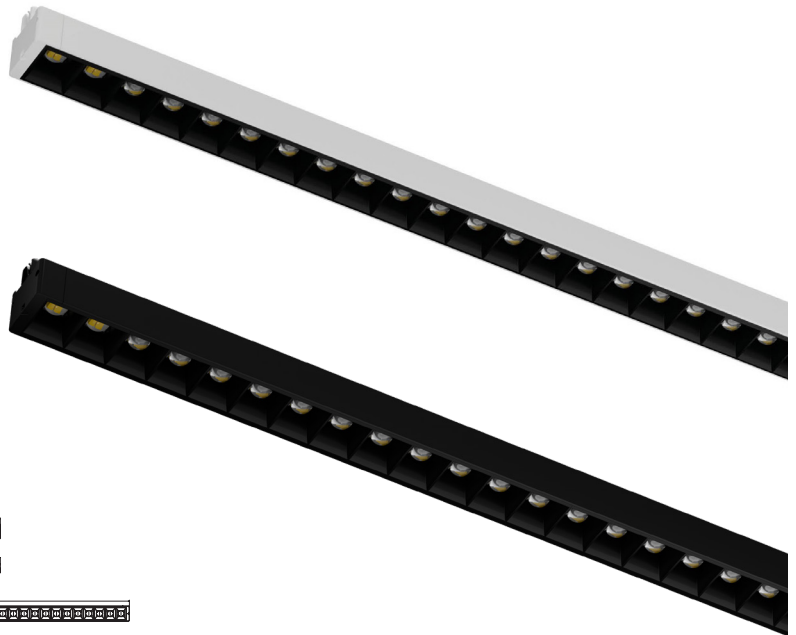

Art. nr.	Lengde	Farge	Kelvin	CRI	Watt	Lumen	UGR	Spredning
351630906	1164mm	<input type="checkbox"/> Hvit (sort innside)	3000K	>90	35W	4550lm	<16	60°
351630905	1164mm	<input checked="" type="checkbox"/> Sort (sort innside)	3000K	>90	35W	4550lm	<16	60°
501630906	1464mm	<input type="checkbox"/> Hvit (sort innside)	3000K	>90	50W	6500lm	<16	60°
501630905	1464mm	<input checked="" type="checkbox"/> Sort (sort innside)	3000K	>90	50W	6500lm	<16	60°

Produktdata

Spesifikasjon	
SDCM	<3
Flicker free	Ja (SVM (≤ 0,4) / Pst LM (≤ 1,0))
Beskyttelsesklasse	III
Materiell armatur	Alu / PC
Type optikk	Reflektor
UGR	<16
IP	20
Driftstemperatur	-20°C - +35°C
LED chip	Elite SMD2835
Strøm / spenning	800mA / 24-48V
Levetid LED	L90B10 50.000T / L80B50 100.000T
Energiklasse LED	C

ALYCE - MODULE R19

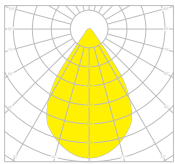

80°

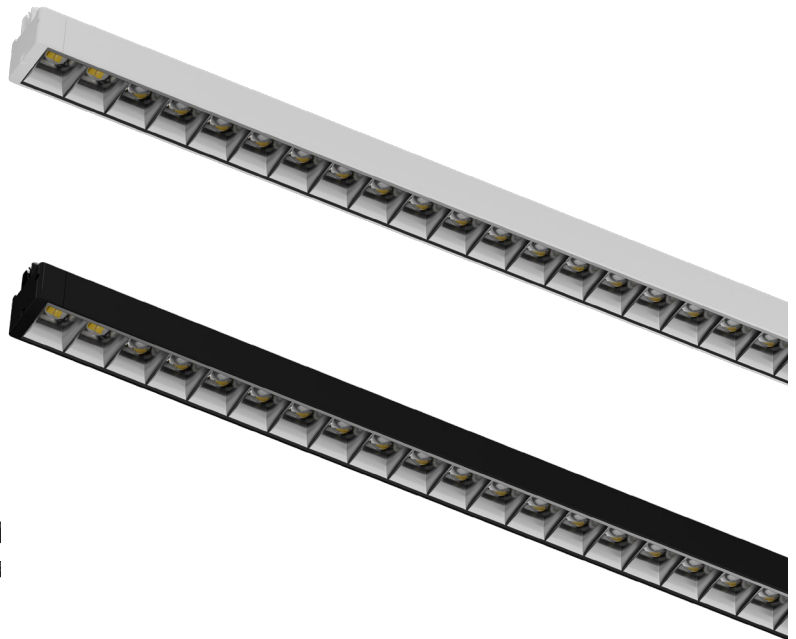

Art. nr.	Lengde	Farge	Kelvin	CRI	Watt	Lumen	UGR	Spredning
351930906	1164mm	<input type="checkbox"/> Hvit (krom innside)	3000K	>90	35W	4900lm	<19	80°
351930905	1164mm	<input checked="" type="checkbox"/> Sort (krom innside)	3000K	>90	35W	4900lm	<19	80°

Produktdata

Spesifikasjon	
SDCM	<3
Flicker free	Ja (SVM ($\leq 0,4$) / Pst LM ($\leq 1,0$))
Beskyttelsesklasse	III
Materiell armatur	Alu / PC
Type optikk	Linse
UGR	<19
IP	20
Driftstemperatur	-20°C - +35°C
LED chip	Elite SMD2835
Strøm / spenning	800mA / 24-48V
Levetid LED	L90B10 50.000T / L80B50 100.000T
Energiklasse LED	C

ALYCE - IN-TRACK

Alyce 3T In-Track er et modulbasert system for 3-tenningsskinne

Alyce 3T In-Track driver benyttes sammen med valgt modul og klikkes enkelt på plass i 3-tenningsskinne (Global Trac).

Systemet er meget fleksibelt, hvor man kan plassere lyset hvor som helst på skinnen. Modulene gir meget lav blending - $UGR < 16$ / $UGR < 19$.

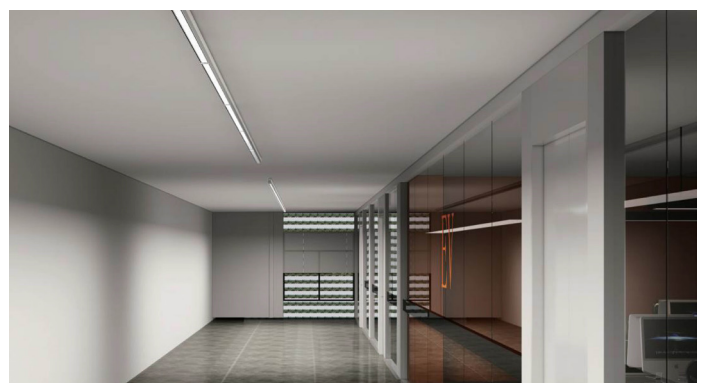
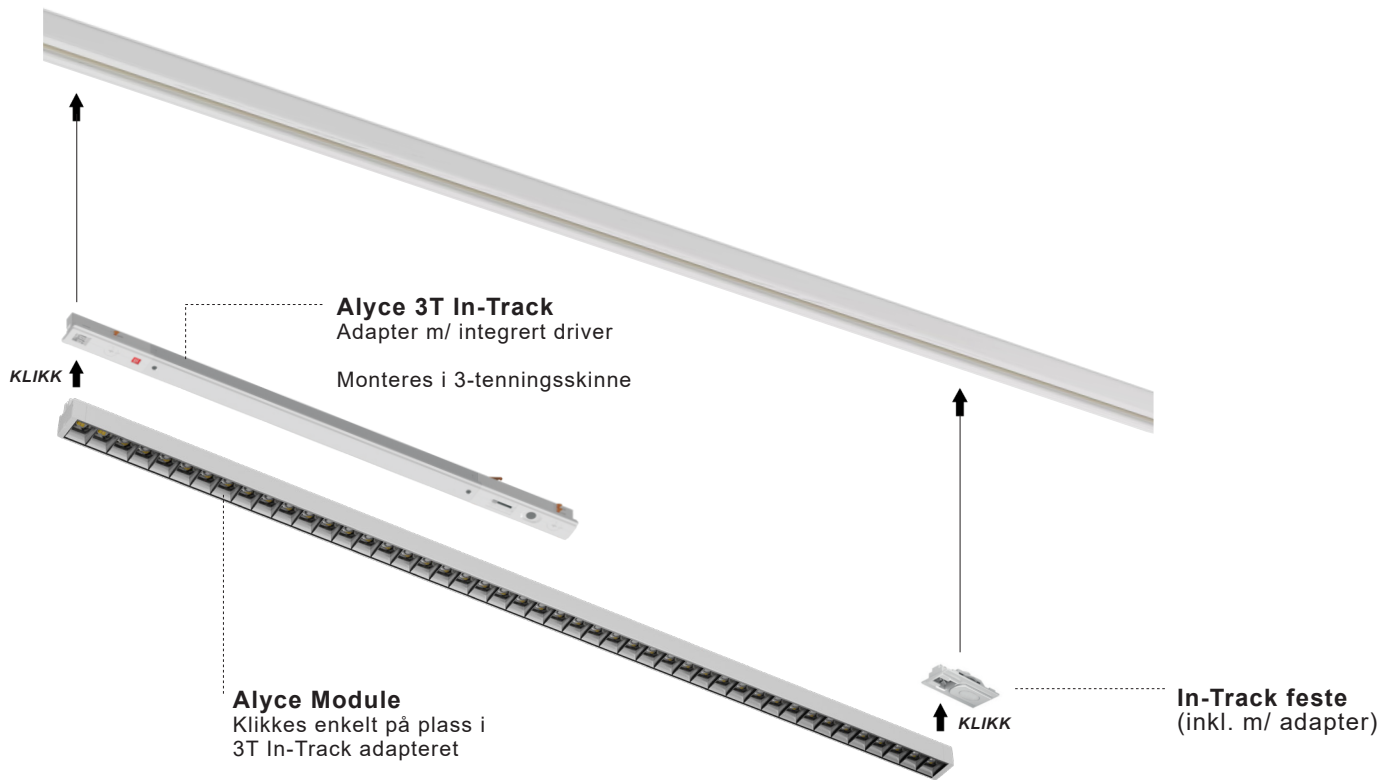

ALYCE - IN-TRACK

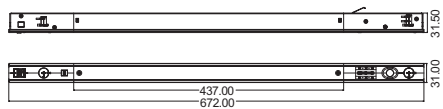
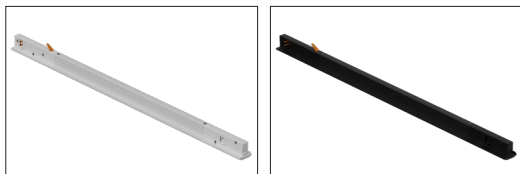

ALYCE 3T IN-TRACK DRIVER 50W

Farge	Art. nr.	Dimbar
Hvit	410500006	Ikke dimbar
Sort	410500005	Ikke dimbar
Hvit	410500306	DALI
Sort	410500305	DALI

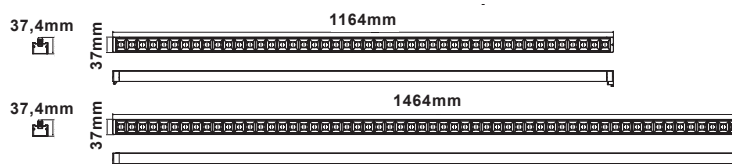
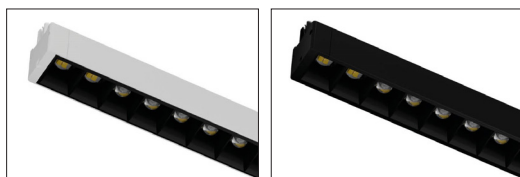

ALYCE MODULE R16

Lengde	Farge	Art. nr.	Teknisk beskrivelse
1164mm	Hvit / sort	351630906	35W, 3000K, 4550lm, CRI>90 - 60° / UGR<16
1164mm	Sort / sort	351630905	35W, 3000K, 4550lm, CRI>90 - 60° / UGR<16
1464mm	Hvit / sort	501630906	50W, 3000K, 6500lm, CRI>90 - 60° / UGR<16
1464mm	Sort / sort	501630905	50W, 3000K, 6500lm, CRI>90 - 60° / UGR<16

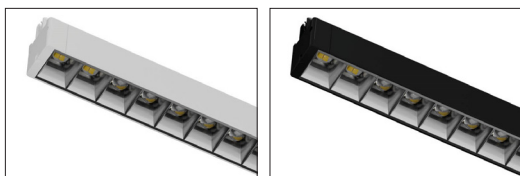

ALYCE MODULE R19

Lengde	Farge	Art. nr.	Teknisk beskrivelse
1164mm	Hvit / Krom	351930906	35W, 3000K, 4900lm, CRI>90 - 80° / UGR<19
1164mm	Sort / Krom	351930905	35W, 3000K, 4900lm, CRI>90 - 80° / UGR<19

Dip-switch på 3T In-Track driver

Endre effekten på modulene ved å justere på dip-switch. NB! 3T In-Track driver står standard på 1050mA.

HERA - ALYCE

Hera Alyce - Utenpåliggende eller nedhengt

Armaturen benyttes med valgt modul og kan enten monteres utenpåliggende eller nedhengt.

Hera-armaturen kan skjøtes sammen, for å oppnå lengre strekk.

Modulene gir meget lav blending - UGR<16

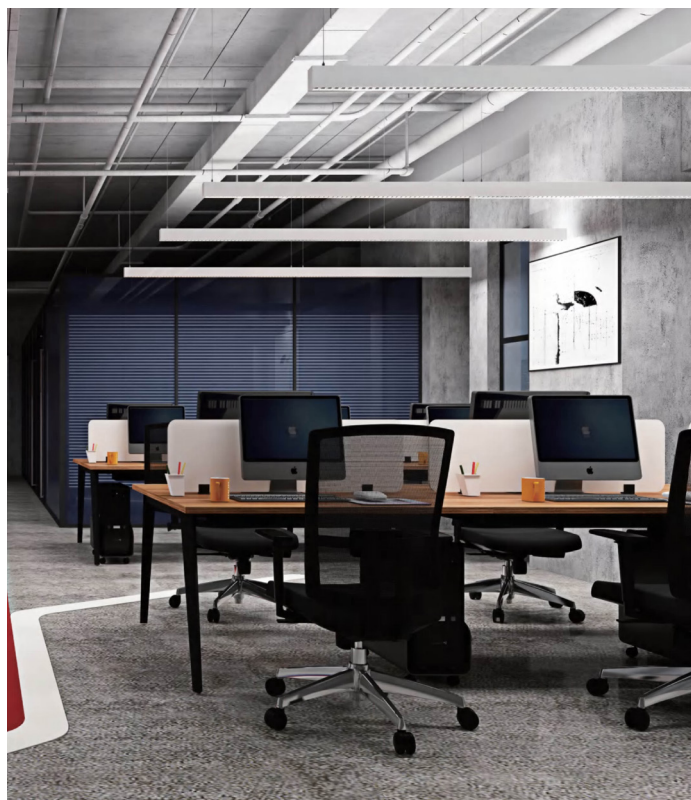
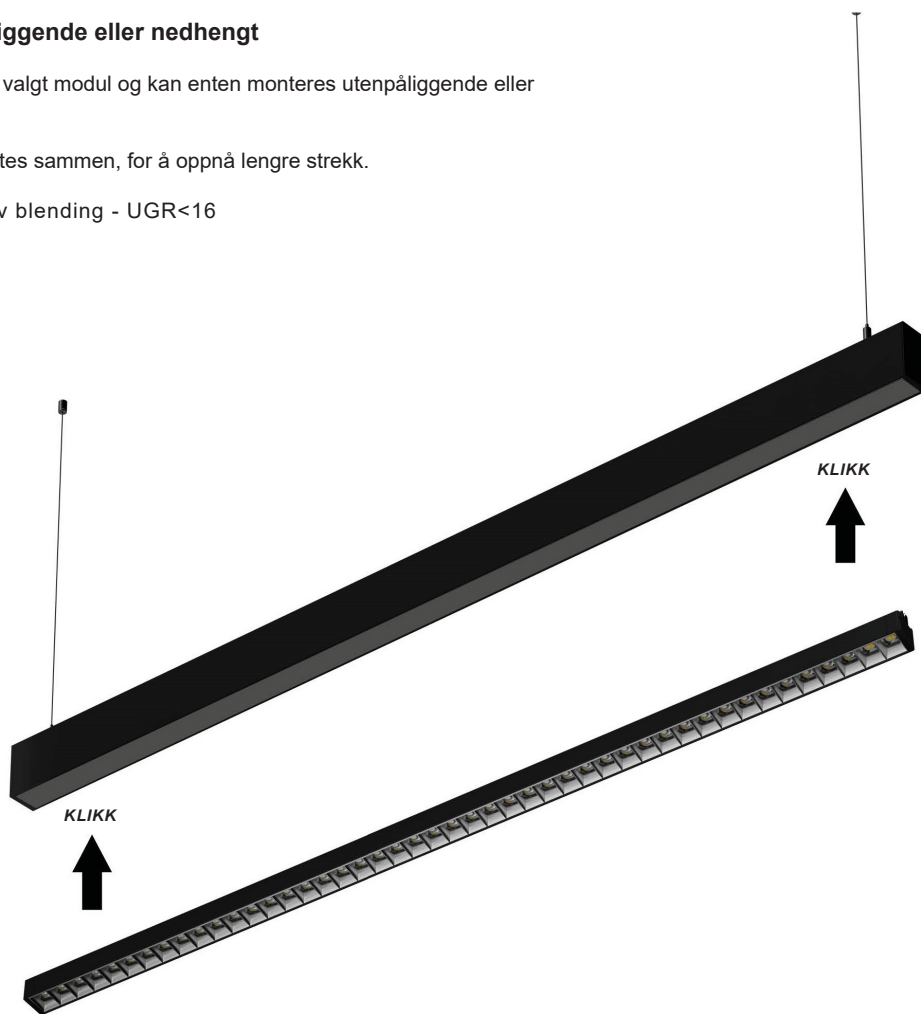

HERA - ALYCE

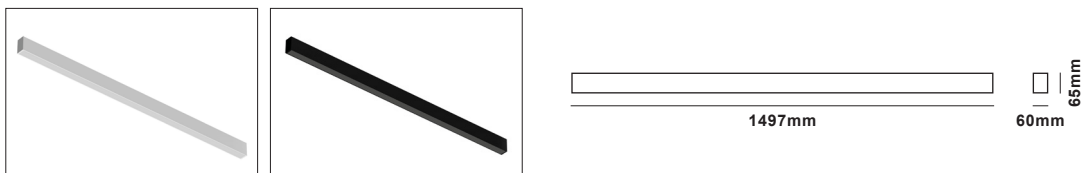

HERA ALYCE PS 50W 1497MM

Farge	Art. nr.	Dimbar
Hvit	671497306	DALI
Sort	671497305	DALI

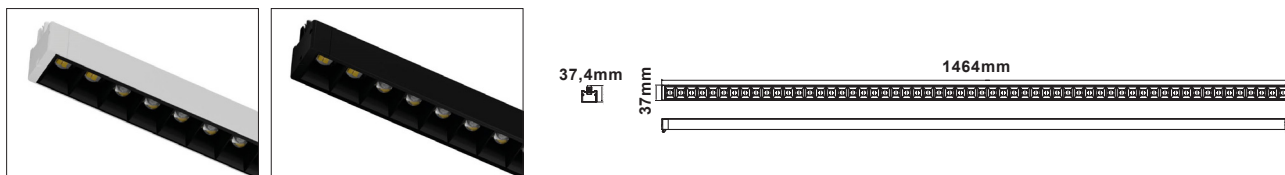

ALYCE MODULE R16

Lengde	Farge	Art. nr.	Teknisk beskrivelse
1464mm	Hvit / sort	501630906	50W, 3000K, 6500lm, CRI>90 - 60° / UGR<16
1464mm	Sort / sort	501630905	50W, 3000K, 6500lm, CRI>90 - 60° / UGR<16

TILBEHØR

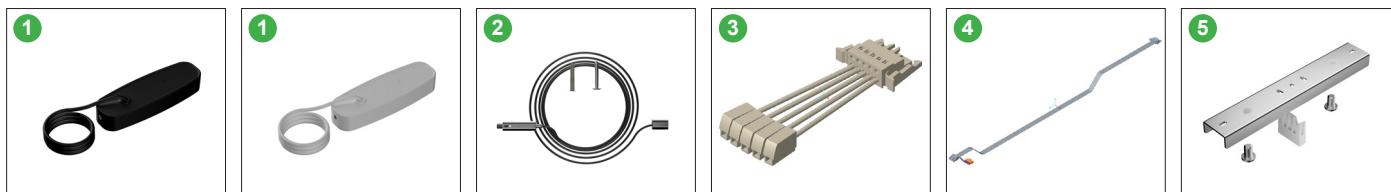

Ceiling canopy / power feed Art. nr. 492000305	Ceiling canopy / power feed Art. nr. 492000306	Suspension kit 2,0m (1 pk.) Art. nr. 492500000	Input terminal for cable connector Art. nr. 492200000	Cable connector Art. nr. 492000000	Connection clamp Art. nr. 491000000
--	--	--	---	--	---

- 1) Takkopp med strømtilkobling og ledning (180cm) + inkl. 1 stk. wire 2,0m
- 2) Wire for bruk sammen med takkopp v/ nedhengt montasje
- 3) Ved sammekobling av flere armaturer i et strekk, skal denne benyttes som strømtilførsel
- 4) Benyttes mellom hver armatur ved sammenkobling av flere armaturer.
- 5) Skjøt/link for å montere to armaturer sammen til en lengre lengde

Dip-switch på driver i Hera-armatur

Endre effekten på modulene ved å justere på dip-switch.

NB! driver står standard på 1000mA.

EOS - ALYCE

Eos Alyce - Innfelt armatur for systemhimling

Armaturen benyttes med valgt modul og kan enten monteres i systemhimling eller i utenpåliggende ramme.

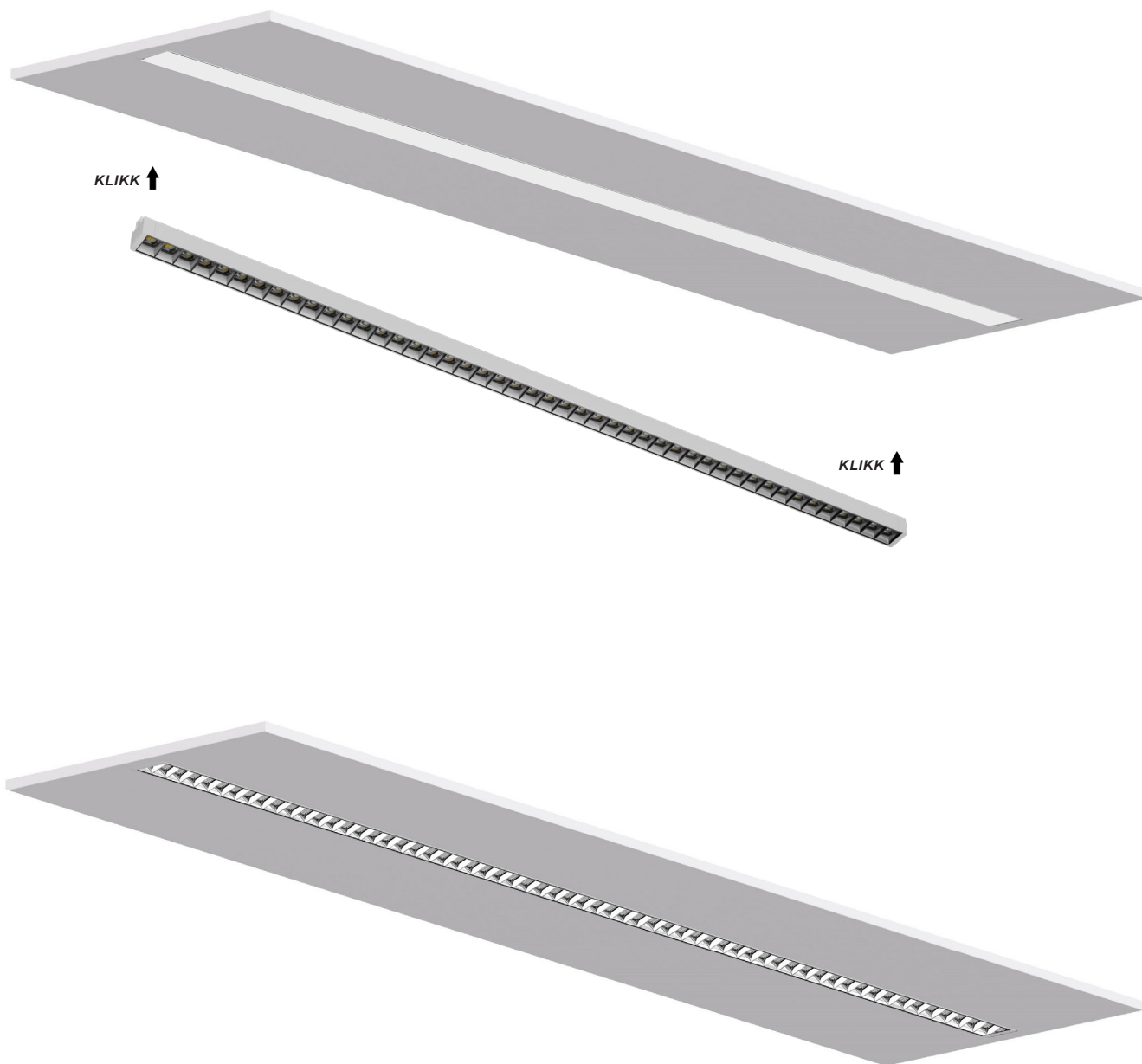

EOS - ALYCE

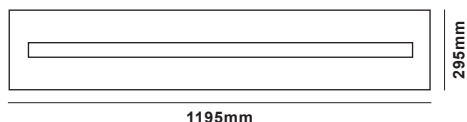
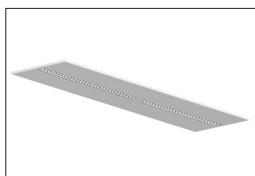

EOS ALYCE PS 42W 295 X 1195MM

Farge	Art. nr.	Dimbar
Hvit	544230123	DALI



ALYCE MODULE R16

Lengde	Farge	Art. nr.	Teknisk beskrivelse
1164mm	Hvit / sort	351630906	35W, 3000K, 4550lm, CRI>90 - 60° / UGR<16
1164mm	Sort / sort	351630905	35W, 3000K, 4550lm, CRI>90 - 60° / UGR<16

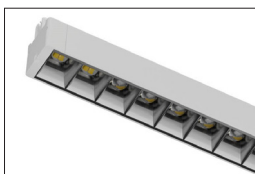

ALYCE MODULE R19

Lengde	Farge	Art. nr.	Teknisk beskrivelse
1164mm	Hvit / Krom	351930906	35W, 3000K, 4900lm, CRI>90 - 80° / UGR<19
1164mm	Sort / Krom	351930905	35W, 3000K, 4900lm, CRI>90 - 80° / UGR<19

TILBEHØR

Fortimo surface 30120

Art. nr. 929002870106

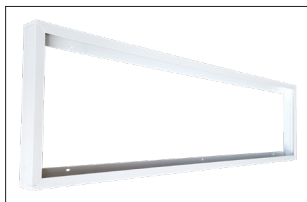

Dip-switch på driver

Endre effekten på modulene ved å justere på dip-switch. NB! Driver står standard på 500mA.



NOR DESIGN

Hovedkontor, lager og showroom Trondheim

Brøsetekra 7, 7069 TRONDHEIM

Showroom Oslo

Drammensveien 130A4, 0277 OSLO

TLF: 73 84 95 50 / WWW.NORDESIGN.NO

