

NOR DESIGN

[www.nordesign.no](http://www.nordesign.no)

# 3-Tenning

Spotter & skinner





# 3-TENNING SKINNER & SPOTTER

## 3-tenning

Global Trac er et skinneresystem som kobles direkte til strømnettet (230V). Populært benyttet i det offentlige rom.

Skinnesystemet er fleksibelt, hvor man kan velge mellom 1m og 2m lengder, samt vinkler og skjøter for å tilpasse etter ønsket behov. Det finnes mange ulike spotter å velge mellom og man kan også benytte pendeladapter for montasje av pendler.



# INNHold

---

## Spotter



**Aria 20W**  
Side 6

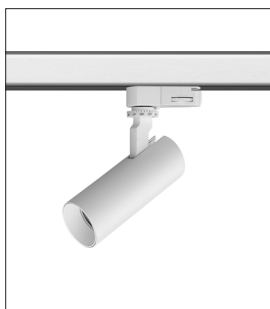

**Ezra 10/15W**  
Side 7



**Arietta 20W**  
Side 8



**Arietta 32W**  
Side 9



**Vivo 13W CT**  
Side 10



**Marcato 30°**  
Side 11



**Marcato 100°**  
Side 11

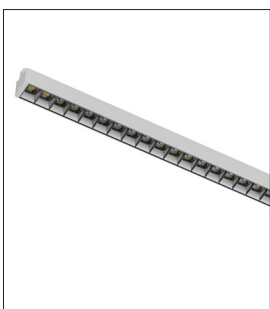

**Alyce**  
Side 12-15

## Global Trac Pro

## Global Trac Pulse (DALI)



**Utenpåliggende**  
Side 15-19



**Innfelt**  
Side 15-19



**Utenpåliggende**  
Side 20-22



**Innfelt**  
Side 20-22

## MONTASJE

Global Trac skinnene kan felles inn, henges ned i wire eller monteres utenpåliggende.

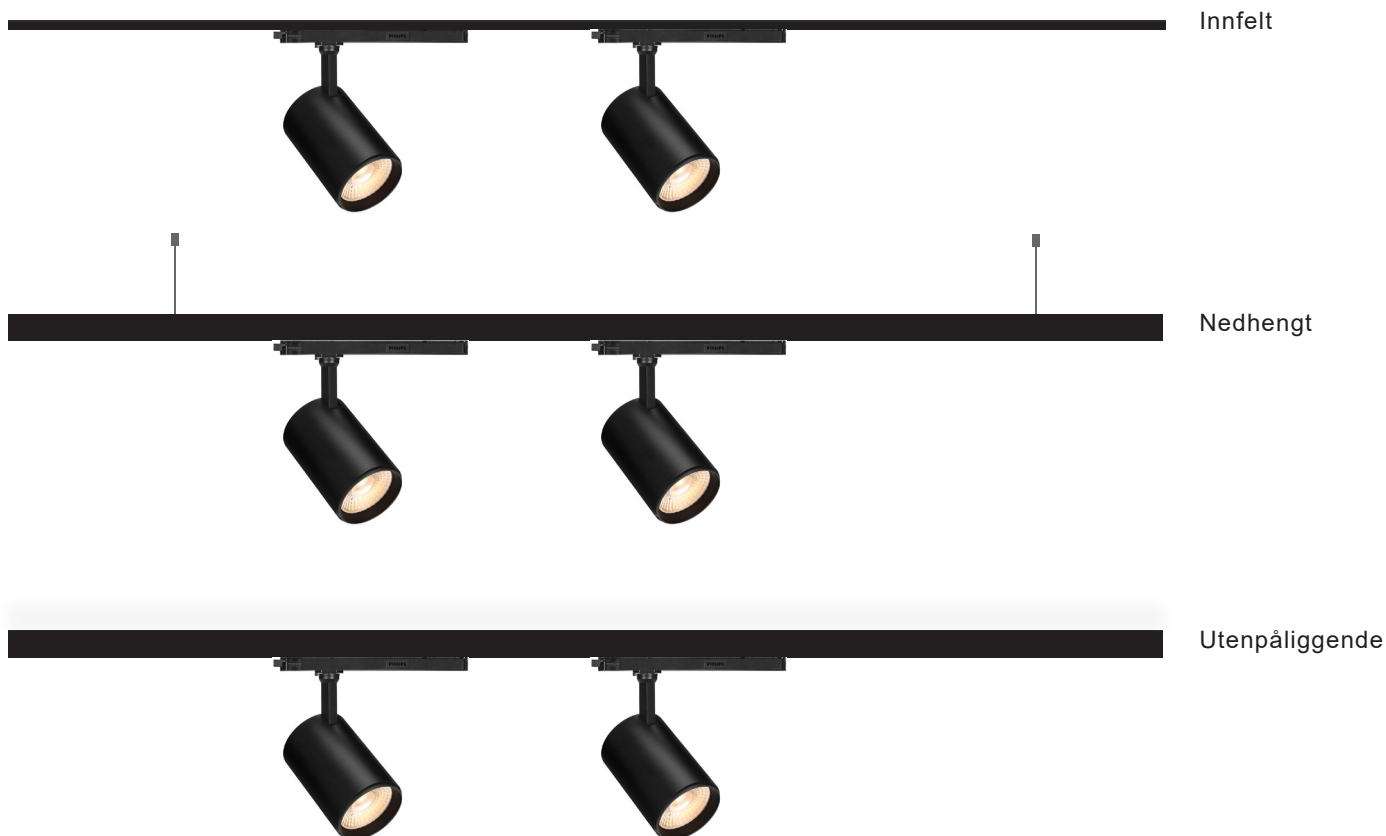

## VALG AV FARGETEMPERATUR

### 2700K, 3000K & Colour Toning

Valg av fargetemperatur er avhengig av funksjonen til lyset og ikke minst smak og behag.

2700K er en standard varmhvit fargetemperatur som benyttes i all hovedsak til bolig, og i offentlige miljøer som vil oppnå en koslig og varm atmosfære, typisk cafe.

3000K er en kjøligere varmhvit fargetemperatur, som benyttes hovedsaklig i offentlige miljøer, typisk klesbutikk, galleri etc.

Colour Toning teknologien gjør det mulig å oppnå en varmere glød fra lyset når det dimmes. Teknologien imiterer den klassiske glødelampen, som vi alle kjenner godt til.

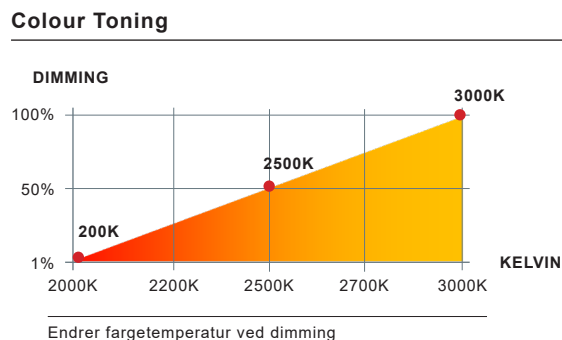
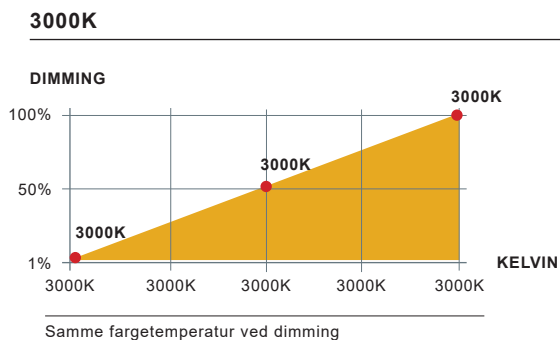

# ARIA



**Lyskilde:** Integrert LED  
**Dimmeteknologi:** Fase avsnitt  
**Beskyttelsesklasse:** II  
**Materiale armaturhus:** Aluminium  
**Materiale avdekning:** PC (transparent)

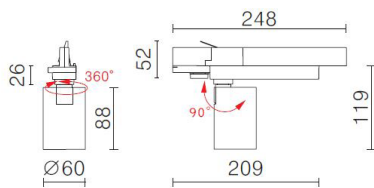
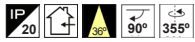

Art. nr.	Farge	Kelvin	CRI	Lumen	Watt	Spredning	Dimbar
381272006	<input type="checkbox"/> Signal white	2700	>90	1820	20	36°	Fase avsnitt
381272005v2	<input checked="" type="checkbox"/> Jet black	2700	>90	1820	20	36°	Fase avsnitt
381302006v2	<input type="checkbox"/> Signal white	3000	>90	2100	20	36°	Fase avsnitt
381302005v2	<input checked="" type="checkbox"/> Jet black	3000	>90	2100	20	36°	Fase avsnitt

**Lyskilde:** Integrert LED  
**Dimmeteknologi:** Fase avsnitt  
**Beskyttelsesklasse:** I  
**Materiale armaturhus:** Aluminium  
**Materiale avdekning:** PC (transparent)

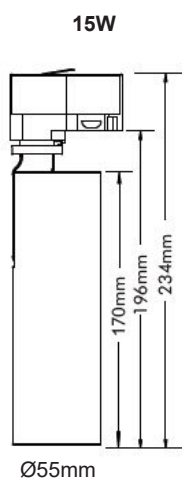
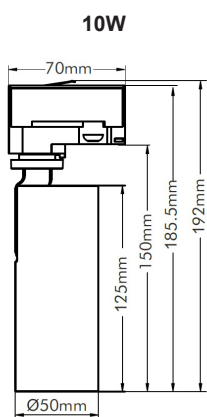

Art. nr.	Farge	Kelvin	CRI	Lumen	Watt	Spredning	Dimbar
164101006	<input type="checkbox"/> Traffic white (RAL9016)	2700	>90	735	10	36°	Fase avsnitt
164101005	<input checked="" type="checkbox"/> Graphite black (RAL9011)	2700	>90	735	10	36°	Fase avsnitt
164301506	<input type="checkbox"/> Traffic white (RAL9016)	3000	>90	1165	15	36°	Fase avsnitt
164301505	<input checked="" type="checkbox"/> Graphite black (RAL9011)	3000	>90	1165	15	36°	Fase avsnitt
164271505	<input checked="" type="checkbox"/> Graphite black (RAL9011)	2700	>90	1142	15	36°	Fase avsnitt

## Tilbehør

### Tilbehør for 10W



Art. nr. 664101500

Art. nr. 664106000

Art. nr. 664100005

Art. nr. 664100034

### Tilbehør for 15W



Art. nr. 664301515

Art. nr. 664301560

Art. nr. 664301505

Art. nr. 664301534

# ARIETTA

**Lyskilde:** Integrrert LED  
**Dimmeteknologi:** DALI  
**Beskyttelsesklasse:** II  
**Materiale armaturhus:** Aluminium  
**Materiale avdekning:** PC (transparent)

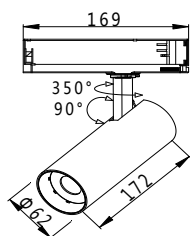
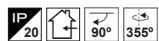

## 20W

Art. nr.	Dimbar	Farge	Kelvin	CRI	Lumen	Watt	Spredning
380302006	<b>Ikke dimbar</b>	<input type="checkbox"/> Signal white (RAL9003)	3000	>90	1704	<b>20</b>	36°
380302005	<b>Ikke dimbar</b>	<input checked="" type="checkbox"/> Signal black (RAL9004)	3000	>90	1704	<b>20</b>	36°
383302006	<b>DALI</b>	<input type="checkbox"/> Signal white (RAL9003)	3000	>90	1704	<b>20</b>	36°
383302005	<b>DALI</b>	<input checked="" type="checkbox"/> Signal black (RAL9004)	3000	>90	1704	<b>20</b>	36°

DALI: Benyttes med Global Trac PULS skinne



# ARIETTA

**Lyskilde:** Integreert LED  
**Dimmeteknologi:** DALI  
**Beskyttelsesklasse:** II  
**Materiale armaturhus:** Aluminium  
**Materiale avdekning:** PC (transparent)

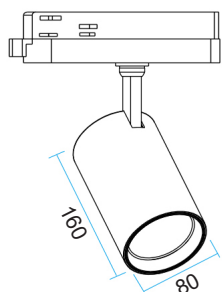
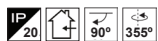

## 32W

Art. nr.	Dimbar	Farge	Kelvin	CRI	Lumen	Watt	Spredning
380303206	<b>Ikke dimbar</b>	<input type="checkbox"/> Signal white (RAL9003)	3000	>90	3100	<b>32</b>	36°
380303205	<b>Ikke dimbar</b>	<input checked="" type="checkbox"/> Signal black (RAL9004)	3000	>90	3100	<b>32</b>	36°
380403205	<b>Ikke dimbar</b>	<input checked="" type="checkbox"/> Signal black (RAL9004)	4000	>90	3250	<b>32</b>	36°
163303206	<b>DALI</b>	<input type="checkbox"/> Signal white (RAL9003)	3000	>90	3100	<b>32</b>	36°
163303205	<b>DALI</b>	<input checked="" type="checkbox"/> Signal black (RAL9004)	3000	>90	3100	<b>32</b>	36°

DALI: Benyttes med Global Trac PULS skinne

## Tilbehør

Reflector 60°



Art. nr. 389003260

**Lyskilde:** Integrert LED  
**Dimmeteknologi:** Fase avsnitt  
**Beskyttelsesklasse:** I

**Materiale armaturhus:** Aluminium  
**Materiale avdekning:** PC (transparent)

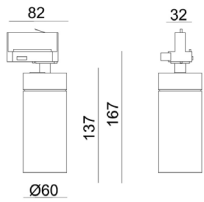
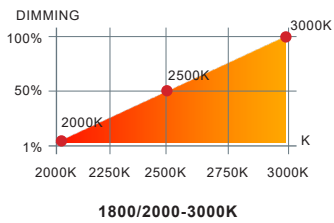
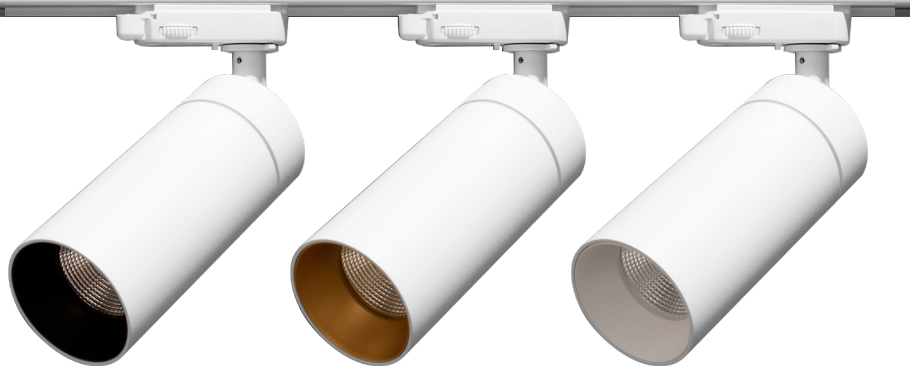
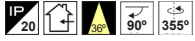

Art. nr.	Farge	Kelvin	CRI	Lumen	Watt	Spredning	Dimbar
160133306	☑ Signal white (RAL9003) / black cuff	2000-3000	>90	1100	13	33°	Fase avsnitt
160133305v3	☑ Graphite black (RAL9011) / golden cuff	1800-3000	>90	920	12	33°	Fase avsnitt

Tilbehør

<p><b>Reflector 24°</b></p>  <p>Art. nr. 660132400</p>	<p><b>Reflector 48°</b></p>  <p>Art. nr. 660134800</p>	<p><b>Cuff Black</b></p>  <p>Art. nr. 364490005</p>	<p><b>Cuff Golden</b></p>  <p>Art. nr. 364490034</p>	<p><b>Cuff White</b></p>  <p>Art. nr. 364490006</p>
--	---	--	---	---

# MARCATO

**Lyskilde:** Integriert LED  
**Dimmeteknologi:** Fase avsnitt  
**Beskyttelsesklasse:** I  
**Materiale armaturhus:** Aluminium  
**Materiale avdekning:** PC (transparent)

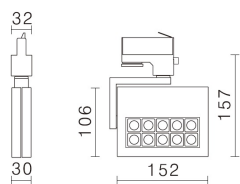
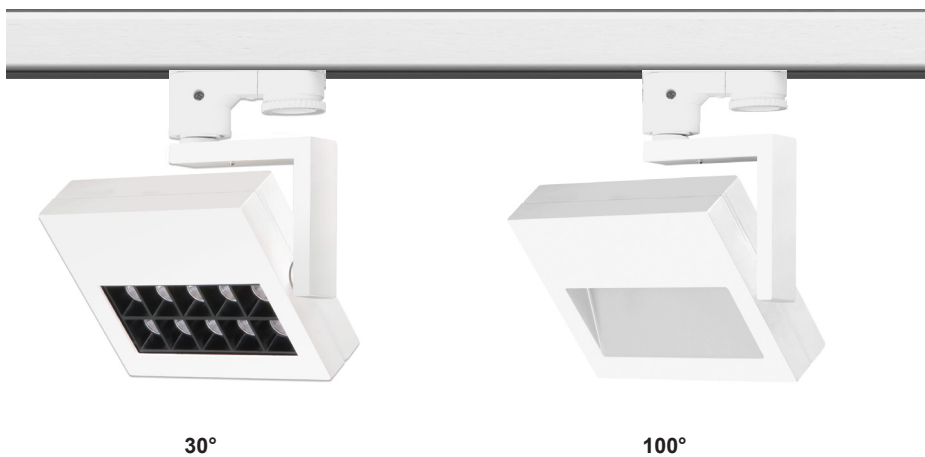

Art. nr.	Farge	Kelvin	CRI	Lumen	Watt	Spredning	Dimbar
380301706v2	White (sort innside)	3000	>80	1019	17	30°	Fase avsnitt

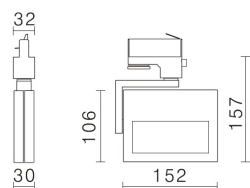
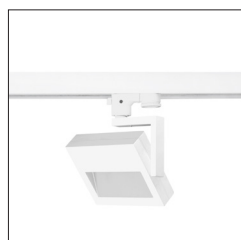

Art. nr.	Farge	Kelvin	CRI	Lumen	Watt	Spredning	Dimbar
380001706v2	White (sølv innside)	3000	>80	1130	17	100°	Fase avsnitt

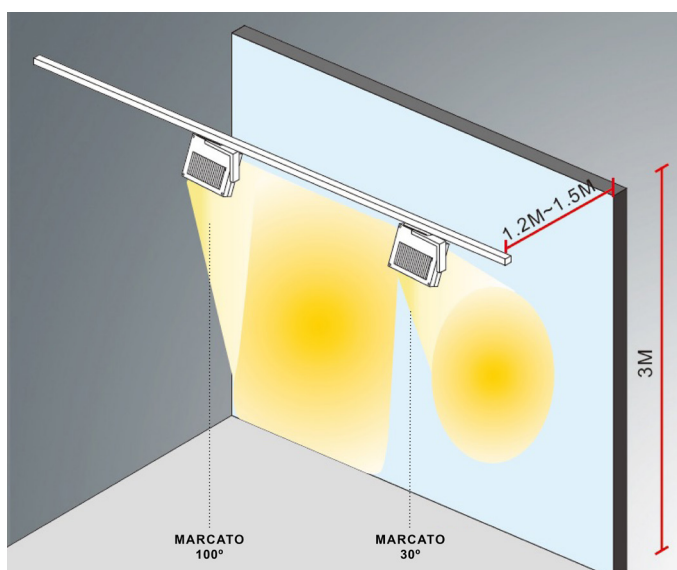

## ALYCE - IN-TRACK

### Alyce 3T In-Track er et modulbasert system for 3-tenningsskinne

Alyce 3T In-Track driver benyttes sammen med valgt modul og klikkes enkelt på plass i 3-tenningsskinne (Global Trac).

Systemet er meget fleksibelt, hvor man kan plassere lyset hvor som helst på skinnen. Modulene gir meget lav blending - UGR<16 / UGR<19.

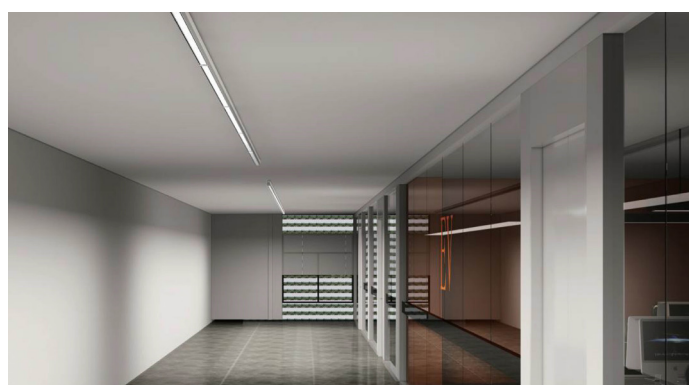
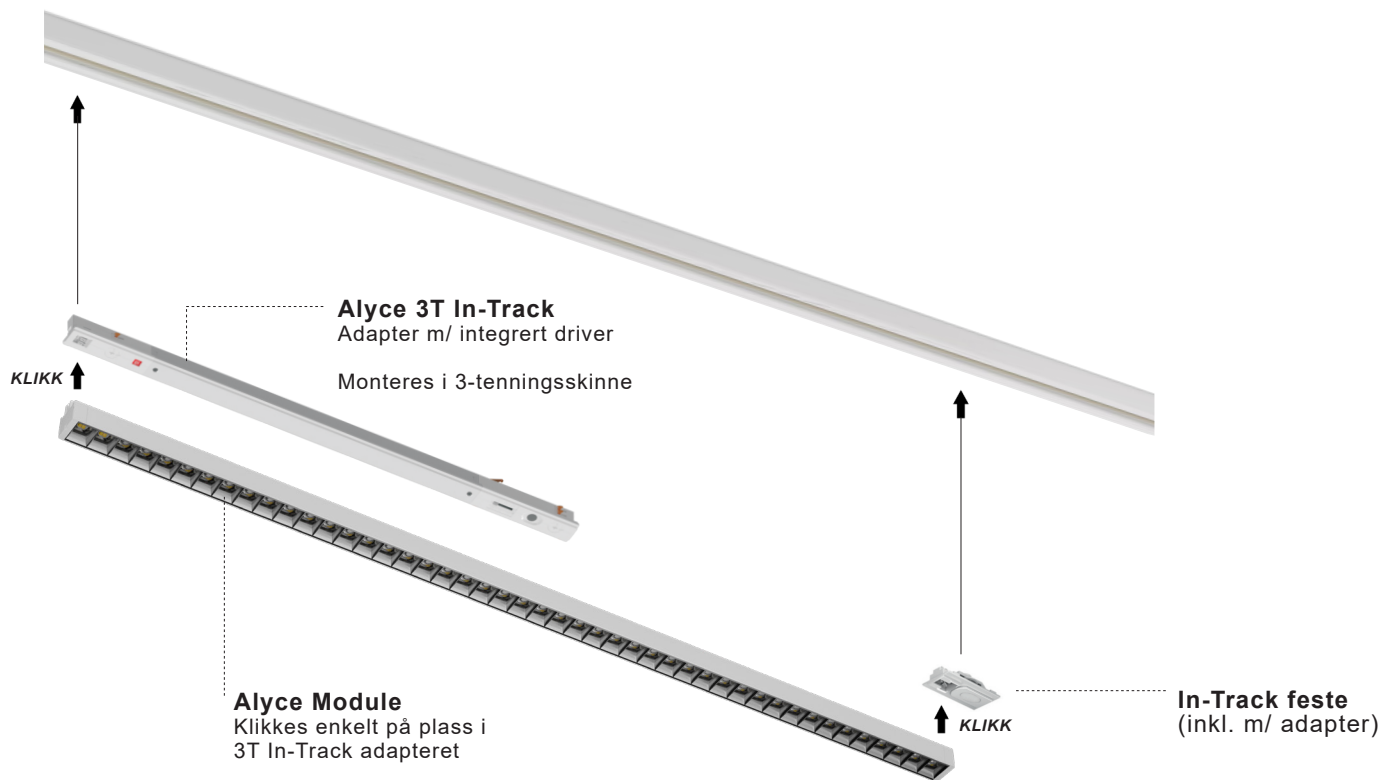

## ALYCE - IN-TRACK

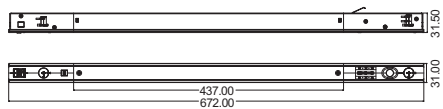
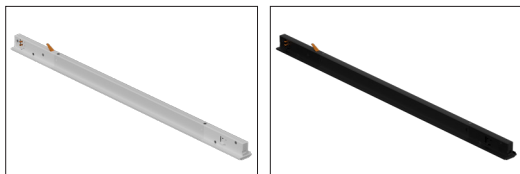

### ALYCE 3T IN-TRACK DRIVER 50W

Farge	Art. nr.	Dimbar
Hvit	410500006	Ikke dimbar
Sort	410500005	Ikke dimbar
Hvit	410500306	DALI
Sort	410500305	DALI

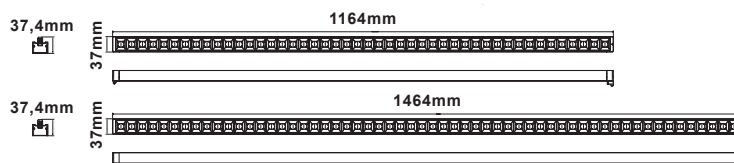

### ALYCE MODULE R16

Lengde	Farge	Art. nr.	Teknisk beskrivelse
1164mm	Hvit / sort	351630906	35W, 3000K, 4550lm, CRI>90 - 60° / UGR<16
1164mm	Sort / sort	351630905	35W, 3000K, 4550lm, CRI>90 - 60° / UGR<16
1464mm	Hvit / sort	501630906	50W, 3000K, 6500lm, CRI>90 - 60° / UGR<16
1464mm	Sort / sort	501630905	50W, 3000K, 6500lm, CRI>90 - 60° / UGR<16

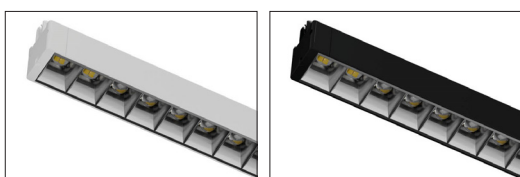

### ALYCE MODULE R19

Lengde	Farge	Art. nr.	Teknisk beskrivelse
1164mm	Hvit / Krom	351930906	35W, 3000K, 4900lm, CRI>90 - 80° / UGR<19
1164mm	Sort / Krom	351930905	35W, 3000K, 4900lm, CRI>90 - 80° / UGR<19

# ALYCE - MODULE R16

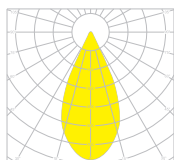

60°

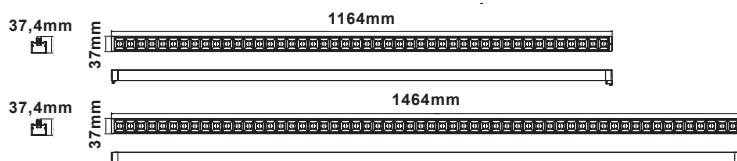
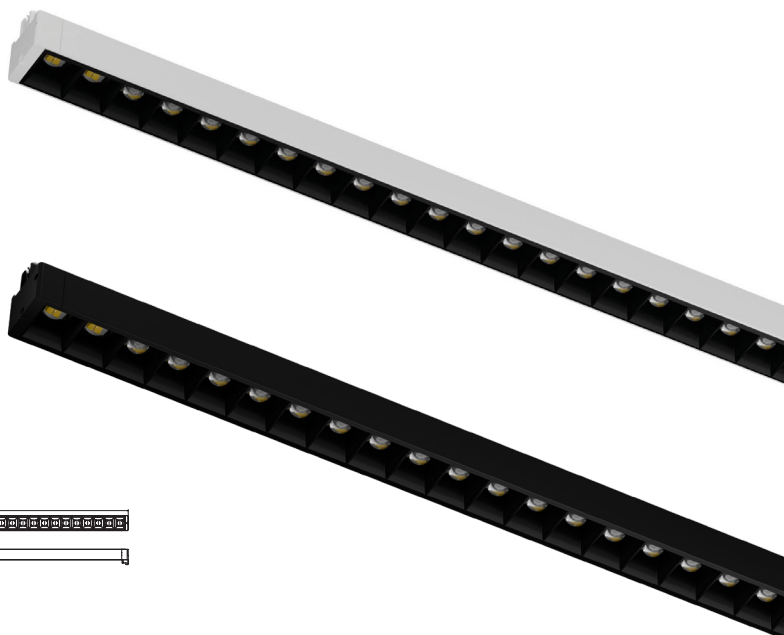

## Produktdata

Spesifikasjon	1164mm	1464mm
SDCM	<3	<3
Flicker free	Ja (SVM (≤ 0,4) / Pst LM (≤ 1,0))	Ja (SVM (≤ 0,4) / Pst LM (≤ 1,0))
Beskyttelsesklasse	III	III
Materiell armatur	Alu / PC	Alu / PC
Type optikk	Reflektor	Reflektor
UGR	<16	<16
IP	20	20
Driftstemperatur	-20°C - +35°C	-20°C - +35°C
LED chip	Elite SMD2835	Elite SMD2835
Strøm / spenning	maks. 800mA / 24-48V	maks. 1050mA / 24-48V
Levetid LED	L90B10 50.000T / L80B50 100.000T	L90B10 50.000T / L80B50 100.000T
Energiklasse LED	C	C

### Dip-switch på 3T In-Track driver

Endre effekten på modulene ved å justere på dip-switch. NB! 3T In-Track driver står standard på 1050mA.

1164mm - Justering av Watt				
Power	Output current	Posisjon		
		1	2	3
38W	800mA	--	ON	--
34W	700mA	ON	ON	--
29W	600mA	--	--	ON
24W	500mA	ON	--	ON
19W	400mA	--	ON	ON
17W	350mA	ON	ON	ON

1464mm - Justering av Watt				
Power	Output current	Posisjon		
		1	2	3
50W	1050mA	--	--	--
43W	900mA	ON	--	--
38W	800mA	--	ON	--
34W	700mA	ON	ON	--
29W	600mA	--	--	ON
24W	500mA	ON	--	ON
19W	400mA	--	ON	ON
17W	350mA	ON	ON	ON

## ALYCE - MODULE R19

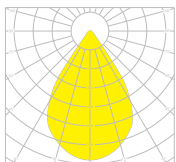

80°

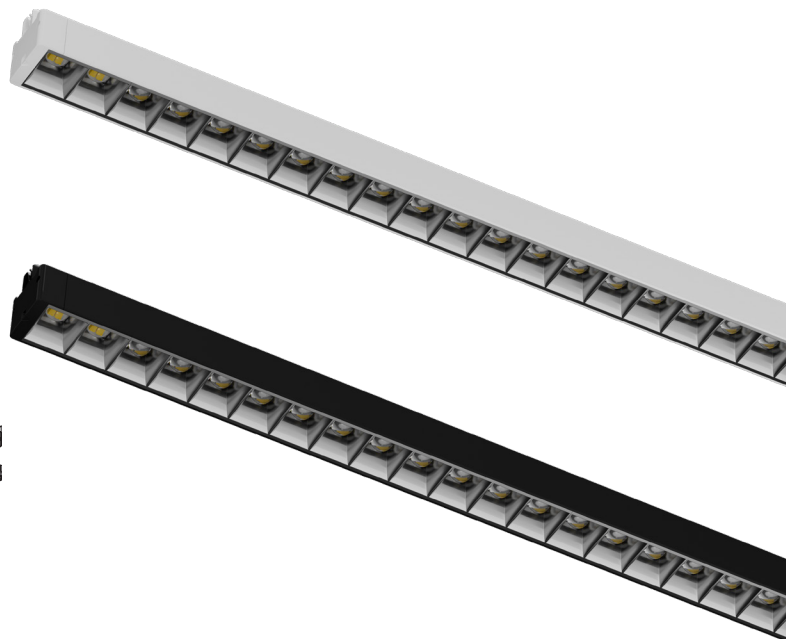

### Produktdata

Spesifikasjon	
SDCM	<3
Flicker free	Ja (SVM ( $\leq 0,4$ ) / Pst LM ( $\leq 1,0$ ))
Beskyttelsesklasse	III
Materiell armatur	Alu / PC
Type optikk	Linse
UGR	<19
IP	20
Driftstemperatur	-20°C - +35°C
LED chip	Elite SMD2835
Strøm / spenning	maks. 800mA / 24-48V
Levetid LED	L90B10 50.000T / L80B50 100.000T
Energiklasse LED	C

### Dip-switch på 3T In-Track driver

Endre effekten på modulene ved å justere på dip-switch. NB! 3T In-Track driver står standard på 1050mA.

1164mm - Justering av Watt				
Power	Output current	Posisjon		
		1	2	3
38W	800mA	--	ON	--
34W	700mA	ON	ON	--
29W	600mA	--	--	ON
24W	500mA	ON	--	ON
19W	400mA	--	ON	ON
17W	350mA	ON	ON	ON

# GLOBAL trac<sup>®</sup>

Global Trac Pro er det mest solgte trekretsbelysningssystemet i verden. Lang erfaring og 100% kvalitetssikring sikrer problemfri drift.



### **Global Trac Pro**

Global Trac Pro er det mest solgte trekretsbelysningssystemet i verden. Lang erfaring og 100% kvalitetssikring sikrer problemfri drift. Diverse installasjonsalternativer er en del av systemet, hvor man har et bredt utvalg av vinkler, skjøter og diverse tilbehør.



### **Global Trac Pulse**

Global Trac Pulse er en DALI utgave av Global Trac Pro. Like fleksibelt system, hvor man har like stort utvalg av deler. NB! Benytt DALI-dimbare spotter til disse skinnene.



# GLOBAL TRAC PRO

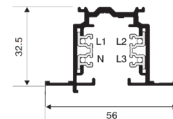
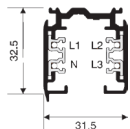

## Utenpåliggende

Art. nr.	Lengde	Farge
XTS-4100-3	1M	□ White (RAL9010)
XTS-4100-2	1M	■ Black (RAL9005)
XTS-4200-3	2M	□ White (RAL9010)
XTS-4200-2	2M	■ Black (RAL9005)
XTS-4300-3	3M	□ White (RAL9010)
XTS-4300-2	3M	■ Black (RAL9005)
XTS-4400-3	4M	□ White (RAL9010)
XTS-4400-2	4M	■ Black (RAL9005)

## Innfelt

Art. nr.	Lengde	Farge
XTSF-4100-3	1M	□ White (RAL9010)
XTSF-4100-2	1M	■ Black (RAL9005)
XTSF-4200-3	2M	□ White (RAL9010)
XTSF-4200-2	2M	■ Black (RAL9005)
XTSF-4300-3	3M	□ White (RAL9010)
XTSF-4300-2	3M	■ Black (RAL9005)
XTSF-4400-3	4M	□ White (RAL9010)
XTSF-4400-2	4M	■ Black (RAL9005)

Den anbefalte festeavstanden er 1000mm.

Merk: En belastning som ikke er tyngre enn 10 kg, kan henges på en strømuttakadapter, trekkstyrken er 100 N (1kp = 9,81N) og maksimalt dreiemoment 2,5 Nm (GA-69 5 kg/50 N)

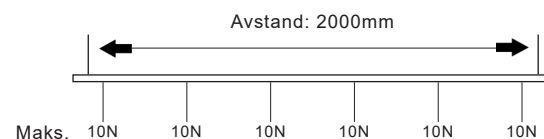
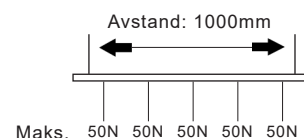

L/mm	a/mm	b/mm	c/mm	d/mm
1000	250	1000	1000	1000
2000	250			
3000	250	1500	1500	1000
4000	250			

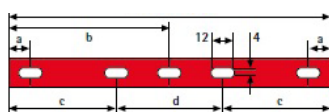

# GLOBAL TRAC PRO

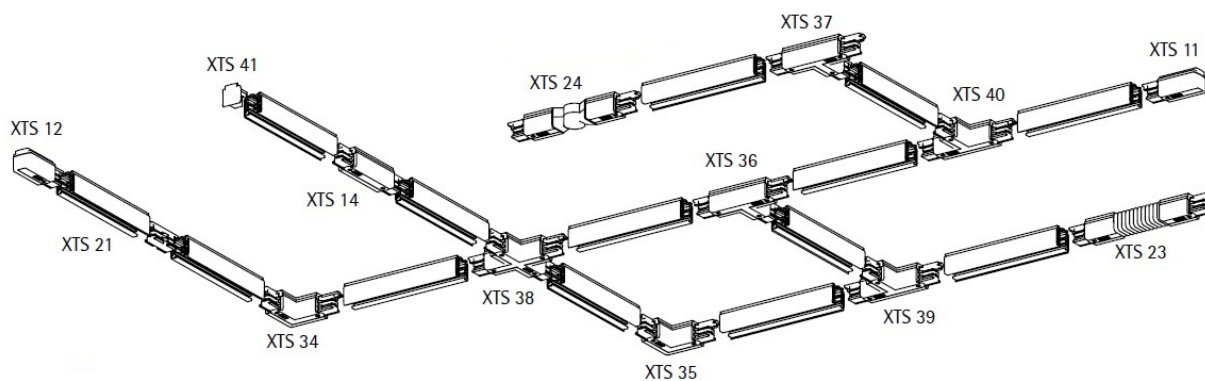



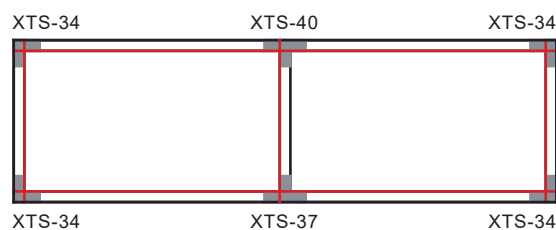
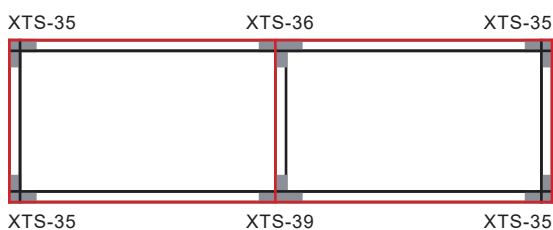







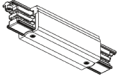
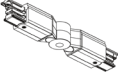
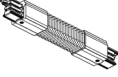



**Bruk av L- og T-tilbehør**  
**Rød linje angir polaritetskammen.**



Illustrasjoner er sett fra bakkenivå.

Bilde	Art. nr.	Farge	Komponent	Strømførende retning
	XTS-11-3	<input type="checkbox"/> White	End Feed	Right
	XTS-11-2	<input checked="" type="checkbox"/> Black	End Feed	Right
	XTS-12-3	<input type="checkbox"/> White	End Feed	Left
	XTS-12-2	<input checked="" type="checkbox"/> Black	End Feed	Left
	XTS-34-3	<input type="checkbox"/> White	L Feed	Inside
	XTS-34-2	<input checked="" type="checkbox"/> Black	L Feed	Inside
	XTS-35-3	<input type="checkbox"/> White	L Feed	Outside
	XTS-35-2	<input checked="" type="checkbox"/> Black	L Feed	Outside
	XTS-40-3	<input type="checkbox"/> White	T Feed	Inside Right
	XTS-40-2	<input checked="" type="checkbox"/> Black	T Feed	Inside Right
	XTS-37-3	<input type="checkbox"/> White	T Feed	Inside Left
	XTS-37-2	<input checked="" type="checkbox"/> Black	T Feed	Inside Left
	XTS-36-3	<input type="checkbox"/> White	T Feed	Outside Right
	XTS-36-2	<input checked="" type="checkbox"/> Black	T Feed	Outside Right
	XTS-39-3	<input type="checkbox"/> White	T Feed	Outside Left
	XTS-39-2	<input checked="" type="checkbox"/> Black	T Feed	Outside Left

# GLOBAL TRAC PRO

Bilde	Art. nr.	Farge	Komponent
	XTS-38-3	<input type="checkbox"/> White	<b>X Feed</b>
	XTS-38-2	<input checked="" type="checkbox"/> Black	<b>X Feed</b>
	XTS-14-3	<input type="checkbox"/> White	<b>Middle Connector</b>
	XTS-14-2	<input checked="" type="checkbox"/> Black	<b>Middle Connector</b>
	XTS-24-3	<input type="checkbox"/> White	<b>Adjustable Corner Connector</b>
	XTS-24-2	<input checked="" type="checkbox"/> Black	<b>Adjustable Corner Connector</b>
	XTS-23-3	<input type="checkbox"/> White	<b>Flexible Corner Connector</b>
	XTS-23-2	<input checked="" type="checkbox"/> Black	<b>Flexible Corner Connector</b>
	XTS-21-3	<input type="checkbox"/> White	<b>Straight Connector</b>
	XTS-21-2	<input checked="" type="checkbox"/> Black	<b>Straight Connector</b>
	XTS-41-3	<input type="checkbox"/> White	<b>End Cap</b>
	XTS-41-2	<input checked="" type="checkbox"/> Black	<b>End Cap</b>
	XTS-68-3	<input type="checkbox"/> White	<b>Multi adapter</b>
	XTS-68-2	<input checked="" type="checkbox"/> Black	<b>Multi adapter</b>
	GA-510-3	<input type="checkbox"/> White	<b>Nippel for adapter</b>
	GA-510-2	<input checked="" type="checkbox"/> Black	<b>Nippel for adapter</b>
	SPW 11WLC-3/3M	<input type="checkbox"/> White	<b>Wire kit - 3M</b>
	SPW 11WLC-2/3M	<input checked="" type="checkbox"/> Black	<b>Wire kit - 3M</b>
	SKB-18-3	<input type="checkbox"/> White	<b>Suspension Clamp for track connection</b>
	SKB-18-2	<input checked="" type="checkbox"/> Black	<b>Suspension Clamp for track connection</b>
	XTSP-11-3	<input type="checkbox"/> White	<b>Cover strip 3000mm</b>
	XTSP-11-2	<input checked="" type="checkbox"/> Black	<b>Cover strip 3000mm</b>
	XTSF-10-3	<input type="checkbox"/> White	<b>Cover plate - For XTS-11 til XTS-14</b>
	XTSF-10-2	<input checked="" type="checkbox"/> Black	<b>Cover plate - For XTS-11 til XTS-14</b>
	XTSF-30-3	<input type="checkbox"/> White	<b>Cover plate - For XTS-34 til XTS-40</b>
	XTSF-30-2	<input checked="" type="checkbox"/> Black	<b>Cover plate - For XTS-34 til XTS-40</b>
	XTSA-67S-3	<input type="checkbox"/> White	<b>Schuko adapter</b>
	XTSA-67S-2	<input checked="" type="checkbox"/> Black	<b>Schuko adapter</b>
	SKB-11T-3	<input type="checkbox"/> White	<b>Mounting clip for T-bar</b>
	SKB-11T-3	<input checked="" type="checkbox"/> Black	<b>Mounting clip for T-bar</b>
	SKB-10-1	<input type="checkbox"/> Alu	<b>Fast mounting "click"</b>
	XTSV-12	<input checked="" type="checkbox"/> Blue	<b>Bending tool for power wires</b>

# GLOBAL TRAC PULSE

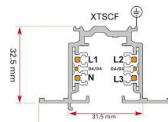
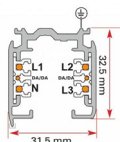
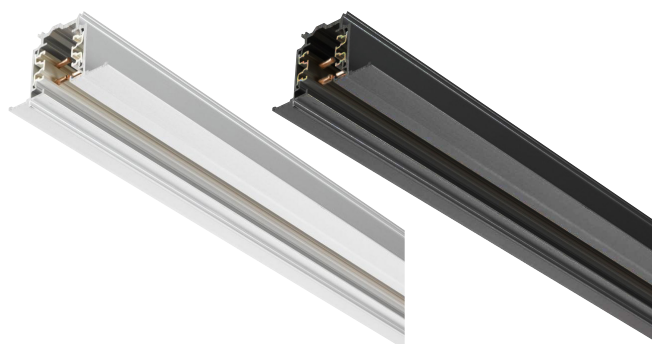

## Utenpåliggende

Art. nr.	Lengde	Farge
XTSC-6100-3	1M	□ White (RAL9010)
XTSC-6100-2	1M	■ Black (RAL9005)
XTSC-6200-3	2M	□ White (RAL9010)
XTSC-6200-2	2M	■ Black (RAL9005)
XTSC-6300-3	3M	□ White (RAL9010)
XTSC-6300-2	3M	■ Black (RAL9005)
XTSC-6400-3	4M	□ White (RAL9010)
XTSC-6400-2	4M	■ Black (RAL9005)

## Innfelt

Art. nr.	Lengde	Farge
XTSCF-6100-3	1M	□ White (RAL9010)
XTSCF-6100-2	1M	■ Black (RAL9005)
XTSCF-6200-3	2M	□ White (RAL9010)
XTSCF-6200-2	2M </td <td>■ Black (RAL9005)</td>	■ Black (RAL9005)
XTSCF-6300-3	3M	□ White (RAL9010)
XTSCF-6300-2	3M	■ Black (RAL9005)
XTSCF-6400-3	4M	□ White (RAL9010)
XTSCF-6400-2	4M	■ Black (RAL9005)

Den anbefalte festeavstanden er 1000mm.

Merk: En belastning som ikke er tyngre enn 10 kg, kan henges på en strømuttakadapter, trekkstyrken er 100 N (1kp = 9,81N) og maksimalt dreiemoment 2,5 Nm (GA-69 5 kg/50 N)

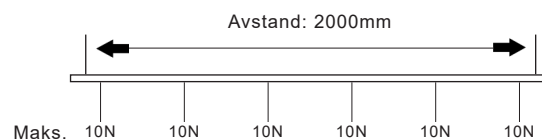
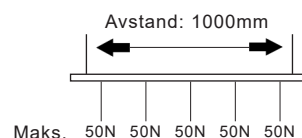

L/mm	a/mm	b/mm	c/mm	d/mm
1000	250	1000	1000	1000
2000	250			
3000	250		1500	1000
4000	250		1500	1000

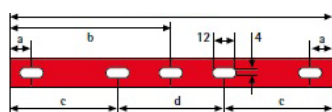

# GLOBAL TRAC PULSE



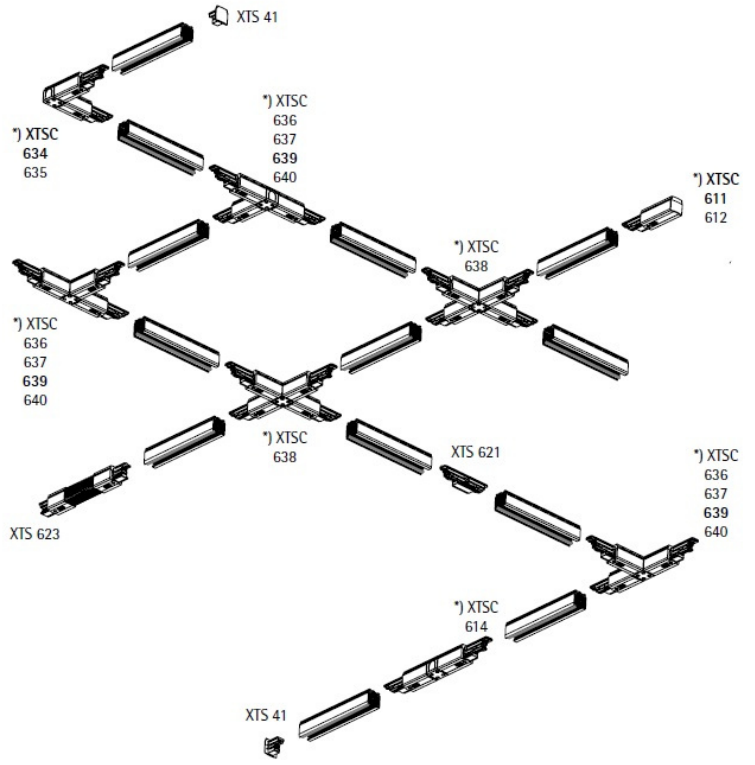
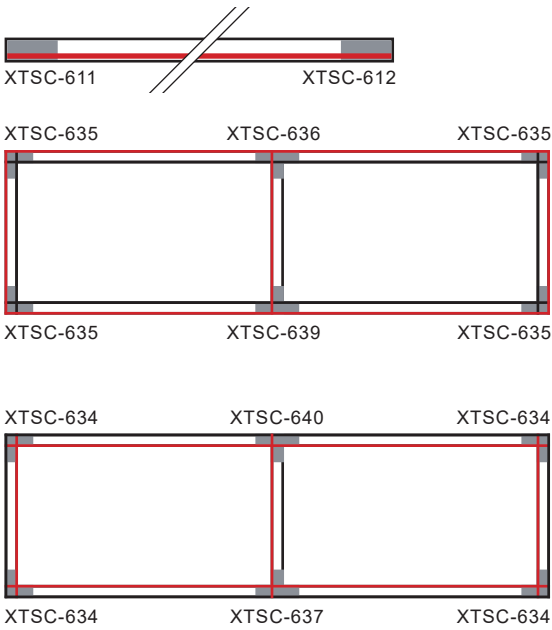







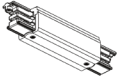
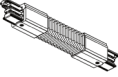

Bruk av L- og T-tilbehør  
Rød linje angir polaritetskammen.



Illustrasjoner er sett fra bakkenivå.

Bilde	Art. nr.	Farge	Komponent	Strømførende retning
	XTSC-611-3	□ White	End Feed	Right
	XTSC-611-2	■ Black	End Feed	Right
	XTSC-612-3	□ White	End Feed	Left
	XTSC-612-2	■ Black	End Feed	Left
	XTSC-634-3	□ White	L Feed	Inside
	XTSC-634-2	■ Black	L Feed	Inside
	XTSC-635-3	□ White	L Feed	Outside
	XTSC-635-2	■ Black	L Feed	Outside
	XTSC-640-3	□ White	T Feed	Inside Right
	XTSC-640-2	■ Black	T Feed	Inside Right
	XTSC-637-3	□ White	T Feed	Inside Left
	XTSC-637-2	■ Black	T Feed	Inside Left
	XTSC-636-3	□ White	T Feed	Outside Right
	XTSC-636-2	■ Black	T Feed	Outside Right
	XTSC-639-3	□ White	T Feed	Outside Left
	XTSC-639-2	■ Black	T Feed	Outside Left

## GLOBAL TRAC PULSE

Bilde	Art. nr.	Farge	Komponent
	XTSC-638-3	<input type="checkbox"/> White	<b>X Feed</b>
	XTSC-638-2	<input checked="" type="checkbox"/> Black	<b>X Feed</b>
	XTSC-614-3	<input type="checkbox"/> White	<b>Middle Connector</b>
	XTSC-614-2	<input checked="" type="checkbox"/> Black	<b>Middle Connector</b>
	XTSC-623-3	<input type="checkbox"/> White	<b>Flexible Corner Connector</b>
	XTSC-623-2	<input checked="" type="checkbox"/> Black	<b>Flexible Corner Connector</b>
	XTSC-621-3	<input type="checkbox"/> White	<b>Straight Connector</b>
	XTSC-621-2	<input checked="" type="checkbox"/> Black	<b>Straight Connector</b>
	XTS-41-3	<input type="checkbox"/> White	<b>End Cap</b>
	XTS-41-2	<input checked="" type="checkbox"/> Black	<b>End Cap</b>
	GAC-600-3	<input type="checkbox"/> White	<b>Multi adapter</b>
	GAC-600-2	<input checked="" type="checkbox"/> Black	<b>Multi adapter</b>
	GA-510-3	<input type="checkbox"/> White	<b>Nippel for adapter</b>
	GA-510-2	<input checked="" type="checkbox"/> Black	<b>Nippel for adapter</b>
	SPW 11WLC-3/3M	<input type="checkbox"/> White	<b>Wire kit - 3M</b>
	SPW 11WLC-2/3M	<input checked="" type="checkbox"/> Black	<b>Wire kit - 3M</b>
	SKB-18-3	<input type="checkbox"/> White	<b>Suspension Clamp for track connection</b>
	SKB-18-2	<input checked="" type="checkbox"/> Black	<b>Suspension Clamp for track connection</b>
	XTSP-11-3	<input type="checkbox"/> White	<b>Cover strip 3000mm</b>
	XTSP-11-2	<input checked="" type="checkbox"/> Black	<b>Cover strip 3000mm</b>
	XTSF-10-3	<input type="checkbox"/> White	<b>Cover plate - For XTS-11 til XTS-14</b>
	XTSF-10-2	<input checked="" type="checkbox"/> Black	<b>Cover plate - For XTS-11 til XTS-14</b>
	XTSF-30-3	<input type="checkbox"/> White	<b>Cover plate - For XTS-34 til XTS-40</b>
	XTSF-30-2	<input checked="" type="checkbox"/> Black	<b>Cover plate - For XTS-34 til XTS-40</b>
	SKB-11T-3	<input type="checkbox"/> White	<b>Mounting clip for T-bar</b>
	SKB-11T-2	<input checked="" type="checkbox"/> Black	<b>Mounting clip for T-bar</b>
	SKB-10-1	<input type="checkbox"/> Alu	<b>Fast mounting "click"</b>
	XTSV-12	<input checked="" type="checkbox"/> Blue	<b>Bending tool for power wires</b>





**NOR DESIGN**

**Hovedkontor, lager og showroom Trondheim**  
Brøsetekra 7, 7069 TRONDHEIM

**Showroom Oslo**  
Drammensveien 130A4, 0277 OSLO

**TLF: 73 84 95 50 / WWW.NORDESIGN.NO**

